

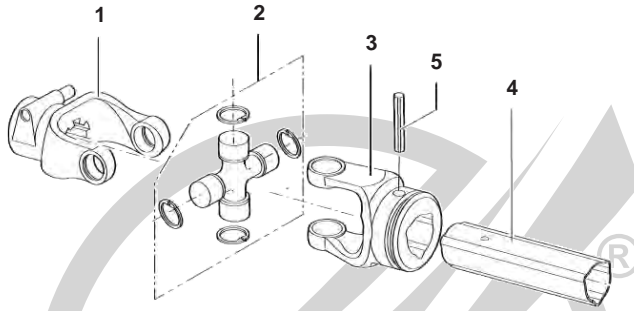

'T' SERIES OUTER SHAFT PARTS

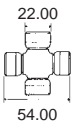
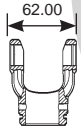
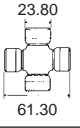
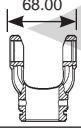
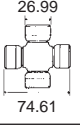
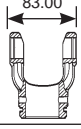
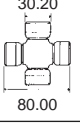
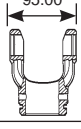
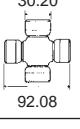
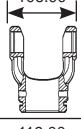
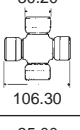
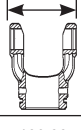
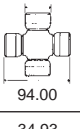
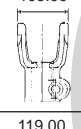
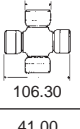
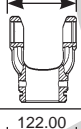
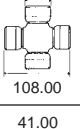
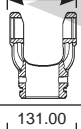

Shaft Identification			QR Yoke 1 3/8 x 6 1	Universal Joint 2	Outer Tube Yoke 3	Outer Tube 4	Outer Roll Pin 5
Series	U/Joint Size	Nominal Yoke Width					
1			T10-021-001	4B12054 <i>(K5-A588)</i>	T10-011-003	191-110-200	190-000-011 50 x 8
2			T20-022-001	4222000 <i>(K5-A64)</i>	T20-012-003	191-120-200	190-000-012# 55 x 8
4			T40-024-001	4232000 <i>(K5-LGB36R)</i>	T40-014-006	191-130-200	191-000-014 65 x 8
5			T50-025-001	4B52079 <i>(K5-A591)</i>	T50-015-011	191-150-200	190-000-016 70 x 10
6			T60-026-001	4622000 <i>(K5-A18R)</i>	T60-016-028	191-160-200	190-000-018 80 x 10
7			T70-027-001	23.00.00 <i>(K5-A536)</i>	T70-017-007	191-160-200	190-000-018 80 x 10
7N			T7N-027-001	4B72094	T7N-017-012	191-160-200	190-000-018
8			T80-028-001	4B82006 <i>(K5-A538)</i>	T80-018-133	191-198-850	190-000-243 90 x 12
9			T90-029-319 <i>Collar Type</i>	41209 <i>(K5-A665)</i>	T90-019-127	191-198-850	190-000-243 90 x 12
10			572100351 <i>Collar Type</i>	41210 <i>(K5-A594)</i>	204106851#		

European PTO





INDENT ITEM ONLY

Document No:	SABRECAT
Issue:	1
Issue Date:	20/04/2019

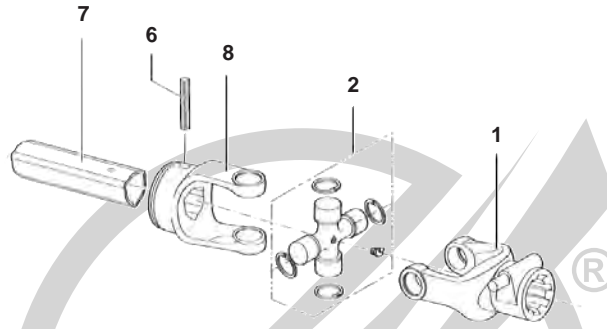
European PTO

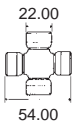
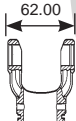
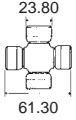
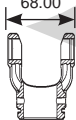
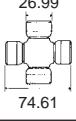
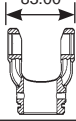
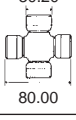
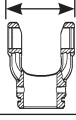
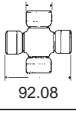
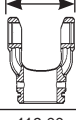
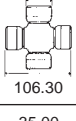
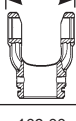
'T' SERIES INNER SHAFT PARTS

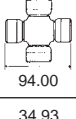
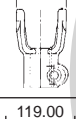
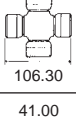
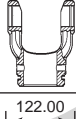
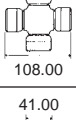
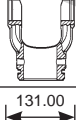

Shaft Identification			Inner Roll Pin 6	Inner Tube 7	Inner Tube Yoke 8	Complete Shaft 1 3/8x6 QR both Ends	
Series	U/Joint Size	Nominal Yoke Width					
1	 22.00 54.00	 62.00	190-000-010# 45 x 8	191-110-100	T10-011-002	T10-1010F112112 1010mm C-C	-
2	 23.80 61.30	 68.00	190-000-011 50 x 8	191-120-100	T20-012-002	T20-1010F112112 1010mm C-C	-
4	 26.99 74.61	 83.00	190-000-012 55 x 8	191-140-100	T40-014-007	T40-1010F112112 1010mm C-C	T40-1510F112112 1510mm C-C
5	 30.20 80.00	 95.00	190-000-394# 65 x 10	191-150-100	T50-015-012	-	-
6	 30.20 92.08	 106.00	190-000-016 70 x 10	191-150-100	T60-016-029	T60-1010F112112 1010mm C-C	T60-1510F112112 1510mm C-C
7	 30.20 106.30	 119.00	190-000-016 70 x 10	191-170-100	T70-017-006	- 	-
7N	 35.00 94.00	 109.00	190-000-016 70 x 10	191-170-100	T7N-017-011	T7N-1010F112112 1010mm C-C	-
8	 34.93 106.30	 119.00	190-000-271 80 x 10	191-190-300	T80-018-134	T80-1010F112112 1010mm C-C	T80-1510F112112 1510mm C-C
9	 41.00 108.00	 122.00	190-000-243 90 x 12	191-190-300	T90-019-128	-	-
10	 41.00 118.00	 131.00	-	-	204106852	-	-

INDENT ITEM ONLY







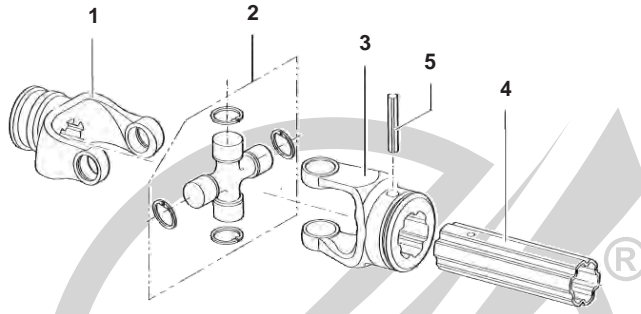

www.walterscheid.com.au

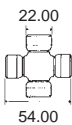
Document No:	SABRECAT
Issue:	1
Issue Date:	20/04/2019

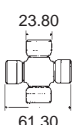
This catalogue is the copyright of HS Company Pty Ltd

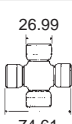
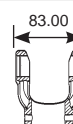
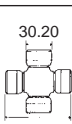
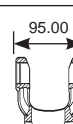
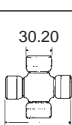
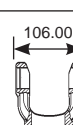
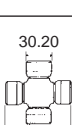
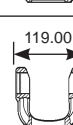
'V' SERIES OUTER SHAFT PARTS

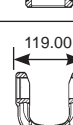

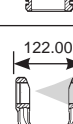
Shaft Identification			QR Yoke 1 3/8 x 6 1	Universal Joint 2	Outer Tube Yoke 3	Outer Tube 4	Outer Roll Pin 5
Series	U/Joint Size	Nominal Yoke Width					
1	22.00  54.00	62.00 					
2	23.80  61.30	68.00 	T20-022-001	4222000 (K5-A64)	V20-012-319#	191-120-800#	190-000-012# 55 x 8
4	26.99  74.61	83.00 	T40-024-001	4232000 (K5-LGB36R)	V40-014-427	191-140-800	190-000-014 65 x 8
5	30.20  80.00	95.00 	T50-025-001	4B52079 (K5-A591)	V50-015-361#	191-160-800	190-000-016 70 x 10
6	30.20  92.08	106.00 	T60-026-001	4622000 (K5-A18R)	V60-016-388	191-160-800	190-000-018 80 x 10
7	30.20  106.30	119.00 					
8	34.93  106.30	119.00 	T80-028-001	4B82006 (K5-A538)	V80-018-241	191-190-800	190-000-243 90 x 12
9	41.00  108.00	122.00 	T90-029-319 Collar Type	41209 (K5-A665)	V90-019-166	191-190-800	190-000-243 90 x 12

European PTO

INDENT ITEM ONLY

B:7-16

www.walterscheid.com.au



Document No:	SABRECAT
Issue:	1
Issue Date:	20/04/2019

This catalogue is the copyright of HS Company Pty Ltd

European PTO

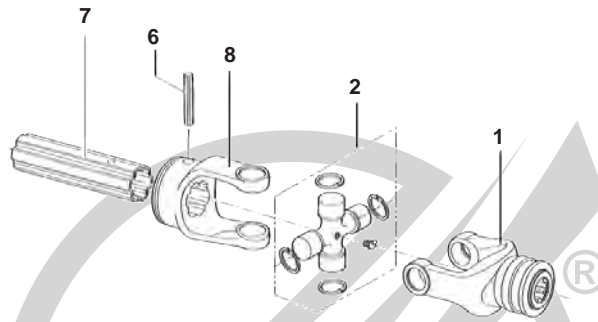
'V' SERIES INNER SHAFT PARTS

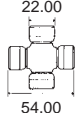
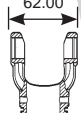
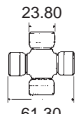
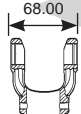
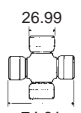
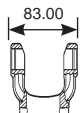
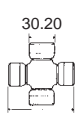
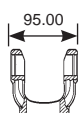
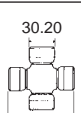
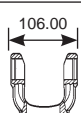
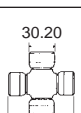
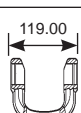

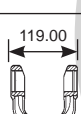
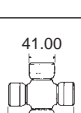
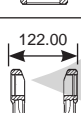
Shaft Identification			Inner Roll Pin 6	Inner Tube 7	Inner Tube Yoke 8	Complete Shaft 1 3/8x6 QR both Ends Collar Type Yokes	
Series	U/Joint Size	Nominal Yoke Width					
1	 22.00 54.00	 62.00	-	-	-		
2	 23.80 61.30	 68.00	190-000-011 50 x 8	191-120-700#	V20-012-320#		
4	 26.99 74.61	 83.00	190-000-012# 55 x 8	191-140-700	V40-014-428	V401010ENC12C12 1010mm C-C	V401510ENC12C12 1510mm C-C
5	 30.20 80.00	 95.00	190-000-394# 65 x 10	191-160-700	V50-015-362#		
6	 30.20 92.08	 106.00	190-000-016 70 x 10	191-160-700	V60-016-389	V601010ENC12C12 1010mm C-C	V601510ENC12C12 1510mm C-C
7	 30.20 106.30	 119.00	-	-	-		
8	 34.93 106.30	 119.00	190-000-271 80 x 12	191-190-700	V80-018-242	V801010ENC12C12 1010mm C-C	V801510ENC12C12 1510mm C-C
9	 41.00 108.00	 122.00	190-000-243 90 x 12	191-190-700	V90-019-167	V901010ENC12C12# 1010mm C-C	

www.walterscheid.com.au





Document No:	SABRECAT
Issue:	1
Issue Date:	20/04/2019

This catalogue is the copyright of HS Company Pty Ltd

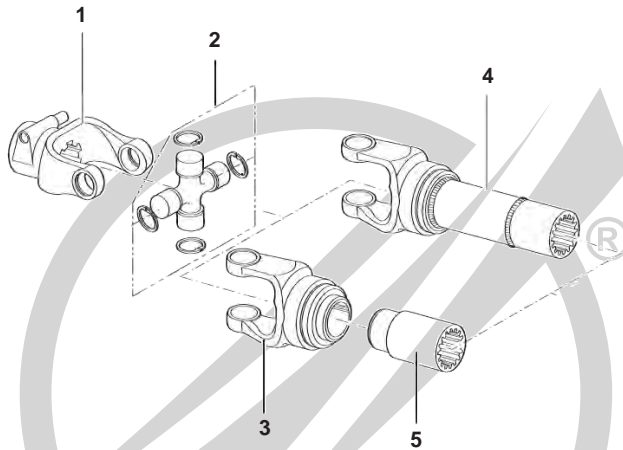
INDENT ITEM ONLY

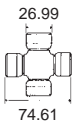
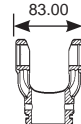
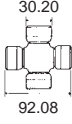
'E' SERIES OUTER SHAFT PARTS

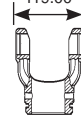

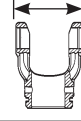
Shaft Identification			QR Yoke	Universal	Weld-in	Outer Tube	Splined
Series	U/Joint Size	Nominal Yoke Width	1 3/8 x 6 1	Joint 2	Tube Yoke 3	4	Sleeve 5
4	26.99  74.61	83.00 	T40-024-001	4232000 (K5-LGB36R)	E40-014-003#	50X4MM	E40-014-249#
6	30.20  92.08	106.00 	T60-026-001	4622000 (K5-A18R)	E60-016-035#	-	E60-016-032#
8	34.93  106.30	119.00 	T80-028-001	4B82006 (K5-A538)	E80-018-144	60X5MM	E80-018-014
9	41.00  108.00	122.00 	T90-029-319 <i>Collar Type</i>	41209 (K5-A665)	E90-019-055	63.5X5.5MM	E90-019-056

European PTO

INDENT ITEM ONLY

B:7-18

www.walterscheid.com.au





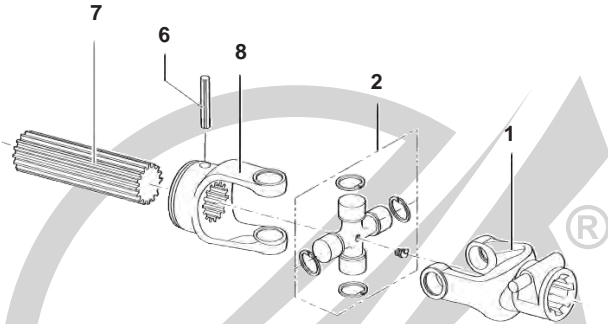

Document No:	SABRECAT
Issue:	1
Issue Date:	20/04/2019

This catalogue is the copyright of HS Company Pty Ltd

European PTO

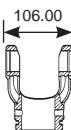
'E' SERIES INNER SHAFT PARTS

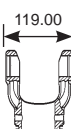

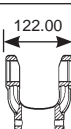
Shaft Identification			Inner Roll Pin 6	Inner Splined Bar 7	Inner Tube Yoke 8	Complete Shaft	Complete Shaft
Series	U/Joint Size	Nominal Yoke Width					
4	26.99  74.61	83.00 	190-000-012# 55 x 8	E40-140-611# 780mm	E40-014-250#	-	-
6	30.20  92.08	106.00 	190-000-016 70 x 10	E60-150-715# 765mm	E60-016-031#	-	-
8	34.93  106.30	119.00 	190-000-018 80 x 10	E80-170-688 735mm	E80-018-145	-	-
9	41.00  108.00	122.00 	190-000-243 90 x 12	E90-190-617 730mm	E90-019-054	-	-

www.walterscheid.com.au



Document No:	SABRECAT
Issue:	1
Issue Date:	20/04/2019

This catalogue is the copyright of HS Company Pty Ltd

INDENT ITEM ONLY

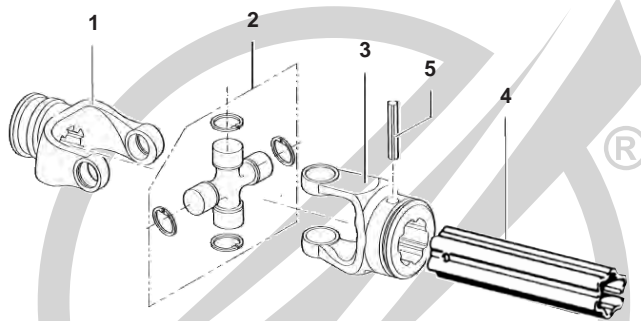
'AGC' SERIES OUTER SHAFT PARTS

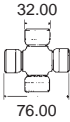
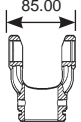
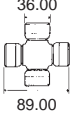
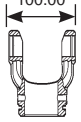

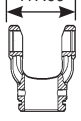
Shaft Identification			QR Yoke 1 3/8 x 6 1	Universal Joint 2	Outer Tube Yoke 3	Outer Tube 4	Outer Roll Pin 5
Series	U/Joint Size	Nominal Yoke Width					
2400	 32.00 76.00	 85.00	AGC35.10.00	4242000 (K5-A592)	AGC35.14.100	AGC75.45.00	61.05.08
2500	 36.00 89.00	 100.00	AGC36.10.00	4252000 (K5-A593)	AGC36.14.100	AGC75.45.00	61.05.12
2600	 42.00 104.00	 117.00	AGC26.10.00	4262000 (K5-A595)	AGC26.14.00	AGC75.46.00	61.06.08

A selection of AGC Series Yokes and Clutches are available in the relevant sections of the Walterscheid DLS and Sabre AG catalogues.

European PTO

INDENT ITEM ONLY

B:7-20

www.walterscheid.com.au

Document No:	SABRECAT
Issue:	1
Issue Date:	20/04/2019

This catalogue is the copyright of HS Company Pty Ltd

European PTO

'AGC' SERIES INNER SHAFT PARTS

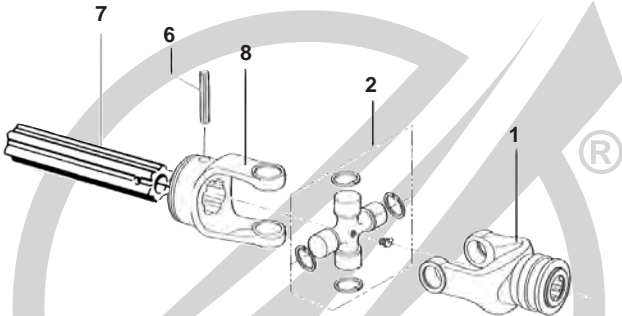

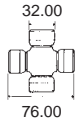
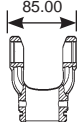
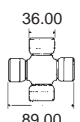
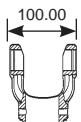
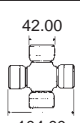
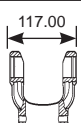
Shaft Identification			Inner Roll Pin 6	Inner Tube 7	Inner Tube Yoke 8	Complete Shaft (No Yokes)	Complete Shaft No Yokes
Series	U/Joint Size	Nominal Yoke Width					
2400	 32.00 76.00	 85.00	61.05.08	AGC75.44.00	AGC35.13.100	AGC2400-SS-101 1010mm	AGC2400-SS-151 1510mm
2500	 36.00 89.00	 100.00	61.05.12	AGC75.44.00	AGC36.13.100	AGC2500-SS-101 1010mm	AGC2500-SS-151 1510mm
2600	 42.00 104.00	 117.00	61.06.08	AGC75.45.00	AGC26.13.00	AGC2600-SS-101 1010mm	AGC2600-SS-141 1410mm

A selection of AGC Series Yokes and Clutches are available in the relevant sections of the Walterscheid DLS and Sabre AG catalogues.

www.walterscheid.com.au

Document No:	SABRECAT
Issue:	1
Issue Date:	20/04/2019

This catalogue is the copyright of HS Company Pty Ltd

INDENT ITEM ONLY

WIDE ANGLE 'V' SERIES OUTER SHAFT PARTS

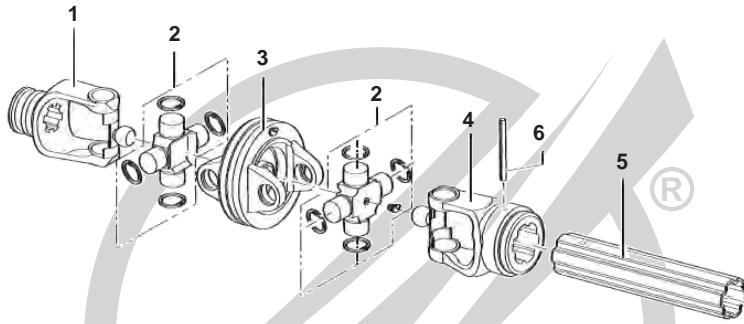

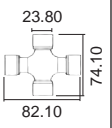
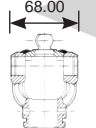
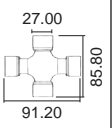
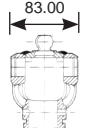
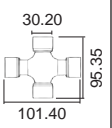
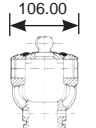
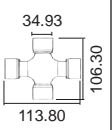
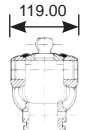
Shaft Identification		QR Yoke 1 3/8 x 6 1	Universal Joint 2	Coupling Yoke 3	Outer Tube Yoke 4	Outer Tube 5
Series	U/Joint Size	Nominal Yoke Width				
2			T20-022-162#	-	T20-022-160#	V20-022-325# 191-120-800#
4			T40-024-261	K5-A734	T40-024-259	V40-024-433 191-140-800
6			T60-026-230	K5-A735	T60-026-224	V60-026-390 191-160-850
8			T80-028-358	K5-A765	T80-028-157	V80-028-248 191-190-850

European PTO

INDENT ITEM ONLY

B:7-22

www.walterscheid.com.au

Document No:	SABRECAT
Issue:	1
Issue Date:	20/04/2019

This catalogue is the copyright of HS Company Pty Ltd

WIDE ANGLE 'V' SERIES INNER SHAFT PARTS

European PTO

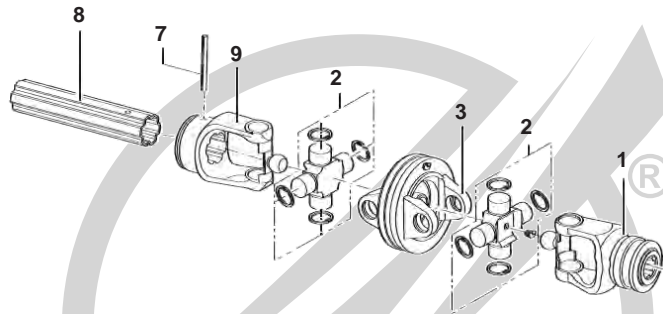

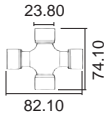
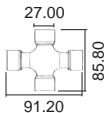
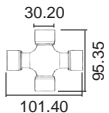
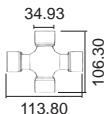
Shaft Id		Outer Roll Pin 6	Inner Roll Pin 7	Inner Tube <i>Rilsan Coated</i> 8	Inner Tube Yoke 9	Complete Shaft
Series	U/Joint Size					
2		190-000-012# 55 x 8	190-000-011 50 x 8	159-220-016# L=1300mm	V20-022-326#	
4		190-000-014 65 x 8	190-000-012# 55 x 8	159-240-018 L=1380mm	V40-024-434#	
6		190-000-018 80 x 10	190-000-016 70 x 10	159-260-179 L=1365mm	V60-026-391	
8		190-000-243 90 x 12	190-000-271 80 x 12	159-280-125 L=1335mm	V80-028-249	

www.walterscheid.com.au

Document No:	SABRECAT
Issue:	1
Issue Date:	20/04/2019



This catalogue is the copyright of HS Company Pty Ltd

INDENT ITEM ONLY

QUICK RELEASE PUSH PIN YOKES

Replacement Quick Release
Push Pin Sets (Original Comer Yokes Only)
1 3/8" Yokes **165-026-004**
1 3/4" Yokes **166-026-005**

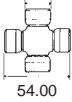
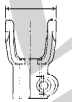
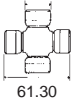
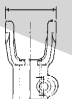
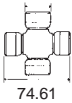
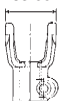
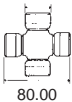
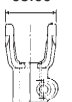
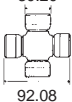
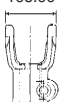
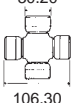
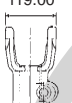
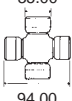
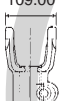
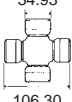
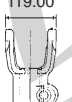
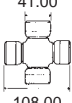

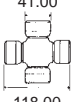
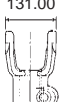
Shaft Identification			1 3/8 6 Spline	1 3/8 21 Spline	1 3/4 6 Spline	1 3/4 20 Spline
Series	U/Joint Size	Nominal Yoke Width				
1	22.00  54.00	62.00 	T10-021-001	T10-021-002	-	-
2	23.80  61.30	68.00 	T20-022-001	T20-022-002	-	-
4	26.99  74.61	83.00 	T40-024-001	T40-024-002	-	-
5	30.20  80.00	95.00 	T50-025-001	T50-025-002#	-	-
6	30.20  92.08	106.00 	T60-026-001	T60-026-002	T60-026-003	T60-026-008
7	30.20  106.30	119.00 	T70-027-001	T70-027-002	-	T70-027-004
7N	35.00  94.00	109.00 	T7N-027-001	T7N-027-002	-	-
8	34.93  106.30	119.00 	T80-028-001	T80-028-002	T80-028-003	T80-028-004
9	41.00  108.00	122.00 	T90-029-001	T90-029-040	T90-029-057	T90-029-058
10	41.00  118.00	131.00 	507100351#	507103751#	-	507103851

INDENT ITEM ONLY

B:7-24

European PTO

www.walterscheid.com.au

Document No:	SABRECAT
Issue:	1
Issue Date:	20/04/2019





















This catalogue is the copyright
of HS Company Pty Ltd

European PTO

QUICK RELEASE COLLAR YOKES

Replacement Quick Release
Collar Sets (Original Comer Yokes Only)
1 3/8" Yokes **165-000-628**
1 3/4" Yokes **165-000-629**



Shaft Identification			1 3/8	1 3/8	1 3/4	1 3/4
Series	U/Joint Size	Nominal Yoke Width	6 Spline	21 Spline	6 Spline	20 Spline
1	22.00  54.00	62.00 	T10-021-319	-	-	-
2	23.80  61.30	68.00 	T20-022-324	T20-022-327	-	-
4	26.99  74.61	83.00 	T40-024-430	T40-024-437	-	-
5	30.20  80.00	95.00 	-	-	-	-
6	30.20  92.08	106.00 	T60-026-544	T60-026-553	T60-026-554	T60-026-555
7	30.20  106.30	119.00 	-	-	-	-
7N	35.00  94.00	109.00 	4B71306	4B71321	-	4B71320
8	34.93  106.30	119.00 	T80-028-423	T80-028-426	T80-028-427	T80-028-428
9	41.00  108.00	122.00 	T90-029-319	T90-029-320	T90-029-317	T90-029-318
10	41.00  118.00	131.00 	572100351	572103751		572103851

www.walterscheid.com.au

Document No:	SABRECAT
Issue:	1
Issue Date:	20/04/2019

This catalogue is the copyright of HS Company Pty Ltd

INDENT ITEM ONLY

WIDE ANGLE QUICK RELEASE PUSH PIN YOKES

Replacement Quick Release
 Push Pin Sets (Original Comer Yokes Only)
 1 3/8" Yokes **165-026-004**
 1 3/4" Yokes **166-026-005**

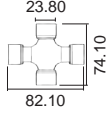
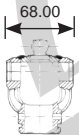
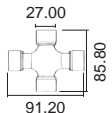
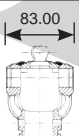
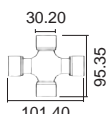
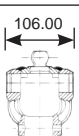
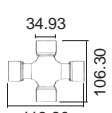
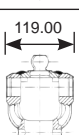

Shaft Identification			1 3/8 6 Spline	1 3/8 21 Spline	1 3/4 6 Spline	1 3/4 20 Spline
Series	U/Joint Size	Nominal Yoke Width				
2			T20-022-162#	T20-022-356#	-	-
4			T40-024-261	T40-024-272#	-	-
6			T60-026-230	T60-026-256#	T60-026-266#	T60-026-267#
8			T80-028-151#	T80-028-177#	T80-028-178#	T80-028-170#

European PTO

INDENT ITEM ONLY

B:7-26

www.walterscheid.com.au

Document No:	SABRECAT
Issue:	1
Issue Date:	20/04/2019

This catalogue is the copyright
 of HS Company Pty Ltd

WIDE ANGLE QUICK RELEASE COLLAR YOKES

Replacement Quick Release
Collar Sets (Original Comer Yokes Only)
1 3/8" Yokes **165-000-628**
1 3/4" Yokes **165-000-629**

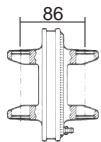
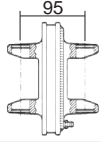
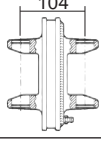
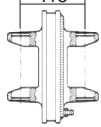

Series	COUPLING YOKE & CENTERING KIT TO SUIT	1 3/8 6 Spline	1 3/8 21 Spline	1 3/4 6 Spline	1 3/4 20 Spline
2	 T20-022-160#	T20-022-330#	T20-022-331#	-	-
4	 T40-024-259	T40-024-439#	T40-024-441#	-	-
6	 T60-026-224	T60-026-503#	T60-026-504	T60-026-557#	T60-026-505
8	 T80-028-157	T80-028-358	T80-028-359	T80-028-361#	T80-028-360

www.walterscheid.com.au

Document No:	SABRECAT
Issue:	1
Issue Date:	20/04/2019

This catalogue is the copyright of HS Company Pty Ltd

INDENT ITEM ONLY

INTERFERING PINCH BOLT YOKES

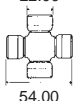
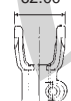
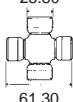
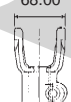
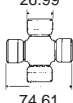
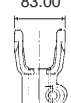
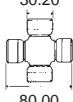
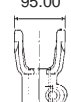
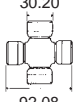
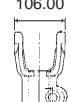
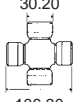
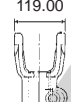
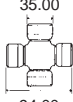
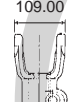
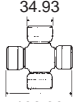
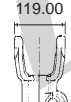
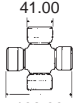
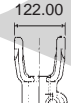
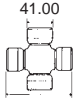
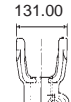

Shaft Identification			1 3/8 6 Spline	1 3/8 21 Spline	1 3/4 6 Spline	1 3/4 20 Spline
Series	U/Joint Size	Nominal Yoke Width				
1	22.00  54.00	62.00 	T10-021-056	-	-	-
2	23.80  61.30	68.00 	T20-022-008	-	-	-
4	26.99  74.61	83.00 	T40-024-014	T40-024-059#	-	-
5	30.20  80.00	95.00 	T50-025-027#	-	-	-
6	30.20  92.08	106.00 	T60-026-047	T60-026-048	T60-026-049#	T60-026-083
7	30.20  106.30	119.00 	T70-027-022#	T70-017-029#	T70-027-024#	T70-027-052#
7N	35.00  94.00	109.00 	-	-	-	-
8	34.93  106.30	119.00 	T80-028-028	T80-028-029	T80-028-030#	T80-028-065
9	41.00  108.00	122.00 	T90-029-022#	-	T90-029-024#	T90-029-068#
10	41.00  118.00	131.00 	-	-	-	-

European PTO















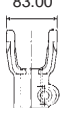

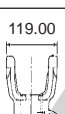

INDENT ITEM ONLY

Document No:	SABRECAT
Issue:	1
Issue Date:	20/04/2019

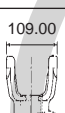
NON-INTERFERING PINCH BOLT YOKES

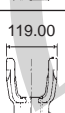

European PTO

Shaft Identification			1 3/8 6 Spline	1 3/8 21 Spline	1 3/4 6 Spline	1 3/4 20 Spline
Series	U/Joint Size	Nominal Yoke Width				
1	22.00  54.00	62.00 	T10-021-059#	-	-	-
2	23.80  61.30	68.00 	T20-022-052#	-	-	-
4	26.99  74.61	83.00 	T40-024-060#	T40-024-061#	-	-
5	30.20  80.00	95.00 	-	-	-	-
6	30.20  92.08	106.00 	T60-026-084	T60-026-085#	-	-
7	30.20  106.30	119.00 	T70-027-053#	T70-027-054#	T70-027-055#	T70-027-056#
7N	35.00  94.00	109.00 	-	-	-	-
8	34.93  106.30	119.00 	T80-028-066#	T80-028-067#	-	T80-028-069#
9	41.00  108.00	122.00 	T90-029-069#	-	T90-029-071#	T90-029-072#
10	41.00  118.00	131.00 	-	-	-	-

www.walterscheid.com.au



















Document No:	SABRECAT
Issue:	1
Issue Date:	20/04/2019

This catalogue is the copyright of HS Company Pty Ltd

INDENT ITEM ONLY

INTERFERING PINCH BOLT BORE & KEY YOKES



Shaft Identification			3/4" Bore 3/16" Key	1" Bore 1/4" Key	1 1/4" Bore 5/16" Key	1 3/8" Bore 5/16" Key	1 1/2" Bore 3/8" Key
Series	U/Joint Size	Nominal Yoke Width					
1	22.00  54.00	62.00 	T10-021-074#	T10-021-075	-	-	-
2	23.80  61.30	68.00 	T20-022-069#	T20-022-070#	-	-	-
4	26.99  74.61	83.00 	-	-	T40-024-076	T40-024-077	-
5	30.20  80.00	95.00 	-	-	-	-	-
6	30.20  92.08	106.00 	-	-	T60-026-103	T60-026-104	-
7	30.20  106.30	119.00 	-	-	-		-
7N	35.00  94.00	109.00 	-	-	-	-	-
8	34.93  106.30	119.00 	-	-	-	T80-028-108	T80-028-109
9	41.00  108.00	122.00 	-	-	-	-	-

European PTO

www.walterscheid.com.au

Document No:	SABRECAT
Issue:	1
Issue Date:	20/04/2019

INDENT ITEM ONLY





B:7-30

This catalogue is the copyright
of HS Company Pty Ltd

European PTO

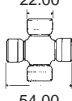
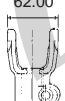
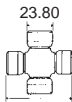
INTERFERING PINCH BOLT BORE & KEY YOKES

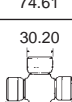
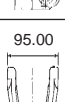
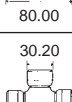
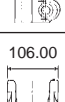
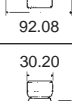
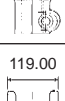
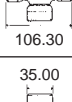
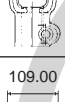
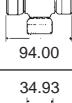
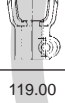
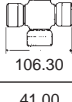
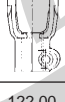

Series	U/Joint Size	Nominal Yoke Width	25mm Bore 8mm Key	30mm Bore 8mm Key	35mm Bore 10mm Key	40mm Bore 12mm Key
1	22.00  54.00	62.00 	T10-021-072#	T10-021-073#	-	-
2	23.80  61.30	68.00 	T20-022-067#	T20-022-068#	-	-
4	26.99  74.61	83.00 	T40-024-072#	T40-024-073#	T40-024-074#	-
5	30.20  80.00	95.00 	-	-	-	-
6	30.20  92.08	106.00 	-	T60-026-100#	T60-026-101#	T60-026-102#
7	30.20  106.30	119.00 	-	-	-	-
7N	35.00  94.00	109.00 	-	-	-	-
8	34.93  106.30	119.00 	-	-	T80-028-076#	T80-028-077#
9	41.00  108.00	122.00 	-	-	-	-

www.walterscheid.com.au



















Document No:	SABRECAT
Issue:	1
Issue Date:	20/04/2019

This catalogue is the copyright of HS Company Pty Ltd

INDENT ITEM ONLY

NON-INTERFERING PINCH BOLT BORE & KEY YOKES



Shaft Identification			3/4" Bore 3/16" Key	1" Bore 1/4" Key	1 1/4" Bore 5/16" Key	1 3/8" Bore 5/16" Key	1 1/2" Bore 3/8" Key
Series	U/Joint Size	Nominal Yoke Width					
1	22.00  54.00	62.00 	T10-021-077#	T10-021-078#	-	-	-
2	23.80  61.30	68.00 	T20-022-072#	T20-022-073#	T20-022-133	-	-
4	26.99  74.61	83.00 	-	-	T40-024-032	T40-024-080	-
5	30.20  80.00	95.00 	-	-	-	-	-
6	30.20  92.08	106.00 	-	-	T60-026-059	T60-026-106	-
7	30.20  106.30	119.00 	-	-	-		-
7N	35.00  94.00	109.00 	-	-	-	-	-
8	34.93  106.30	119.00 	-	-	-	T80-028-106	T80-028-107
9	41.00  108.00	122.00 	-	-	-	-	-

European PTO

www.walterscheid.com.au

Document No:	SABRECAT
Issue:	1
Issue Date:	20/04/2019

INDENT ITEM ONLY





B:7-32

This catalogue is the copyright of HS Company Pty Ltd

European PTO

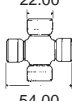
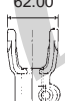
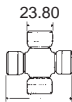
NON-INTERFERING PINCH BOLT BORE & KEY YOKES

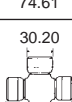
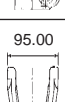
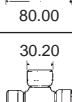
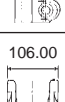
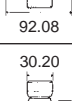
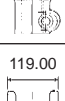
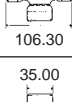
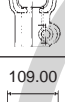
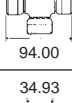
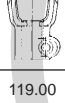
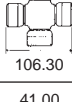
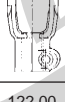

Series	U/Joint Size	Nominal Yoke Width	25mm Bore 8mm Key	30mm Bore 8mm Key	35mm Bore 10mm Key	40mm Bore 12mm Key
1	22.00  54.00	62.00 	T10-021-037#	T10-021-038#	-	-
2	23.80  61.30	68.00 	T20-022-021#	T20-022-022#	-	-
4	26.99  74.61	83.00 	T40-024-078#	T40-024-029	T40-024-028	-
5	30.20  80.00	95.00 	-	-	-	-
6	30.20  92.08	106.00 	-	T60-026-040	T60-026-041	T60-026-052
7	30.20  106.30	119.00 	-	-	-	-
7N	35.00  94.00	109.00 	-	-	-	-
8	34.93  106.30	119.00 	-	-	T80-028-042	T80-028-043
9	41.00  108.00	122.00 	-	-	-	T90-029-079#

www.walterscheid.com.au

Document No:	SABRECAT
Issue:	1
Issue Date:	20/04/2019



This catalogue is the copyright of HS Company Pty Ltd

INDENT ITEM ONLY

PLAIN BORE & KEY YOKES

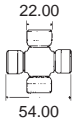
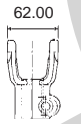
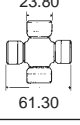
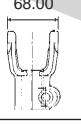
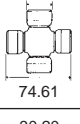
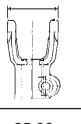
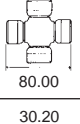
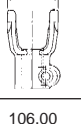
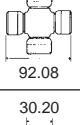
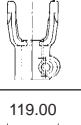
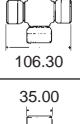
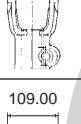
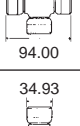
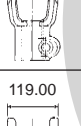
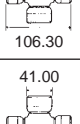
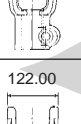
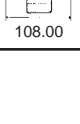

Solid hub available, see next page.

Shaft Identification			3/4" Bore 3/16" Key	1" Bore 1/4" Key	1 1/4" Bore 5/16" Key	1 3/8" Bore 5/16" Key	1 1/2" Bore 3/8" Key
Series	U/Joint Size	Nominal Yoke Width					
1	 22.00 54.00	 62.00	T10-011-064	T10-011-065	T10-011-270#	-	-
2	 23.80 61.30	 68.00	T20-012-057	T20-012-058	T20-012-059	-	-
4	 26.99 74.61	 83.00	-	-	T40-014-065	T40-014-066	-
5	 30.20 80.00	 95.00	-	-	T50-015-069#	T50-015-070#	-
6	 30.20 92.08	 106.00	-	-	T60-016-091	T60-016-092	-
7	 30.20 106.30	 119.00	-	-	-	-	-
7N	 35.00 94.00	 109.00	-	-	-	-	-
8	 34.93 106.30	 119.00	-	-	-	T80-018-306	T80-018-310
9	 41.00 108.00	 122.00	-	-	-	-	-

European PTO

INDENT ITEM ONLY

B:7-34

www.walterscheid.com.au

Document No:	SABRECAT
Issue:	1
Issue Date:	20/04/2019

This catalogue is the copyright of HS Company Pty Ltd

European PTO

PLAIN BORE & KEY YOKES



Series	20mm Bore 6mm Key	25mm Bore 8mm Key	30mm Bore 8mm Key	35mm Bore 10mm Key	40mm Bore 12mm Key	Solid Hub
1	T10-011-061	T10-011-062	T10-011-063#	-	-	-
2	-	T20-012-055	T20-012-056	-	-	T20-012-000 K1-4-A0000 (35 DEGREE)
4	-	T40-014-062	T40-014-063	T40-014-064#	-	T40-014-000
5	-	-	T50-015-066#	T50-015-067#	-	-
6	-	-	T60-016-088	T60-016-089	T60-016-090	T60-016-000
7	-	-	-	-	-	T70-017-000
7N	-	-	-	-	-	-
8	-	-	-	T80-018-070	T80-018-071	T80-018-000
9	-	-	-	-	T90-019-073#	-











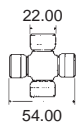
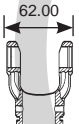

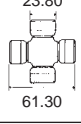
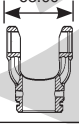

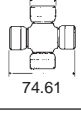
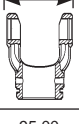

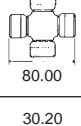
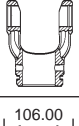

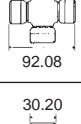
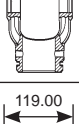
www.walterscheid.com.au

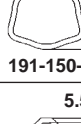
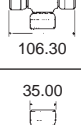
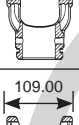
Document No:	SABRECAT
Issue:	1
Issue Date:	20/04/2019

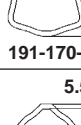
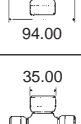
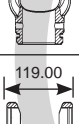
INDENT ITEM ONLY

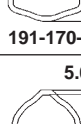
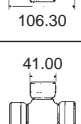
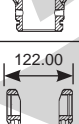
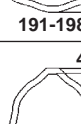
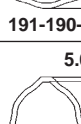
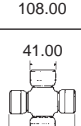
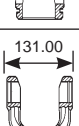
'T' SERIES TRI LOBE TUBE YOKES



Shaft Identification			Outer Tube Yoke	Outer Tube to Suit	Inner Tube Yoke	Inner Tube to Suit
Series	U/Joint Size	Nominal Yoke Width				
1	 22.00 54.00	 62.00	T10-011-003	 2.6 32.5 191-110-200	T10-011-002	 3.5 26.5 191-110-100
2	 23.80 61.30	 68.00	T20-012-003	 3.2 36.0 191-120-200	T20-012-002	 4.0 29.0 191-120-100
4	 26.99 74.61	 83.00	T40-014-006	 3.4 43.5 191-130-200	T40-014-007	 4.5 36.0 191-140-100
5	 30.20 80.00	 95.00	T50-015-011	 3.0 51.6 191-150-200	T50-015-012	 4.0 45.0 191-150-100
6	 30.20 92.08	 106.00	T60-016-028	 4.0 54.0 191-160-200	T60-016-029	 4.0 45.0 191-150-100
7	 30.20 106.30	 119.00	T70-017-007	 4.0 54.0 191-160-200	T70-017-006	 5.5 45.0 191-170-100
7N	 35.00 94.00	 109.00	T7N-017-012	 4.0 54.0 191-160-200	T7N-017-011	 5.5 45.0 191-170-100
8	 35.00 106.30	 119.00	T80-018-133	 4.0 63.0 191-198-850	T80-018-134	 5.0 54.0 191-190-300
9	 41.00 108.00	 122.00	T90-019-127	 4.0 63.0 191-198-850	T90-019-128	 5.0 54.0 191-190-300
10	 41.00 118.00	 131.00				

European PTO

INDENT ITEM ONLY

B:7-36

www.walterscheid.com.au

Document No:	SABRECAT
Issue:	1
Issue Date:	20/04/2019

This catalogue is the copyright of HS Company Pty Ltd

European PTO

'V' SERIES MULTI LOBE TUBE YOKES

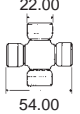
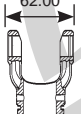
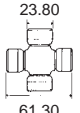
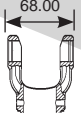
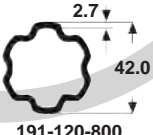
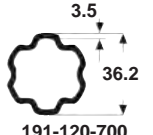
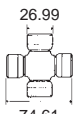
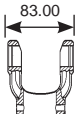
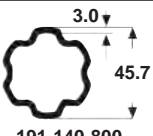
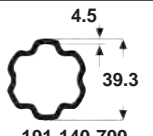
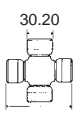
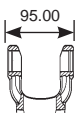
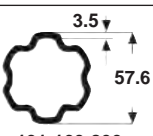
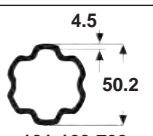
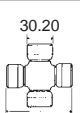
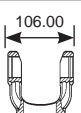
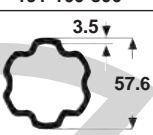
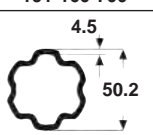
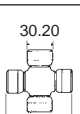
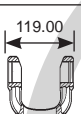
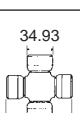
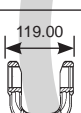
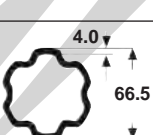
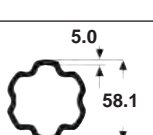
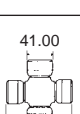
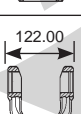
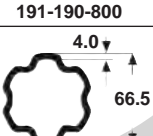
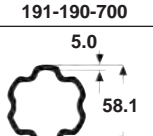
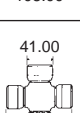
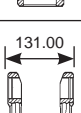

Shaft Identification			Outer Tube Yoke	Outer Tube to Suit	Inner Tube Yoke	Inner Tube to Suit
Series	U/Joint Size	Nominal Yoke Width				
1	22.00  54.00	62.00 				
2	23.80  61.30	68.00 	V20-012-319#	 2.7 42.0 191-120-800	V20-012-320#	 3.5 36.2 191-120-700
4	26.99  74.61	83.00 	V40-014-427	 3.0 45.7 191-140-800	V40-014-428	 4.5 39.3 191-140-700
5	30.20  80.00	95.00 	V50-015-361#	 3.5 57.6 191-160-800	V50-015-362#	 4.5 50.2 191-160-700
6	30.20  92.08	106.00 	V60-016-388	 3.5 57.6 191-160-800	V60-016-389	 4.5 50.2 191-160-700
7	30.20  106.30	119.00 				-
8	34.93  106.30	119.00 	V80-018-241	 4.0 66.5 191-190-800	V80-018-242	 5.0 58.1 191-190-700
9	41.00  108.00	122.00 	V90-019-166	 4.0 66.5 191-190-800	V90-019-167	 5.0 58.1 191-190-700
10	41.00  118.00	131.00 				

www.walterscheid.com.au

Document No:	SABRECAT
Issue:	1
Issue Date:	20/04/2019

This catalogue is the copyright of HS Company Pty Ltd

INDENT ITEM ONLY

'E' SERIES SPLINES & TUBE YOKES



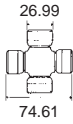
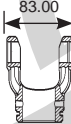
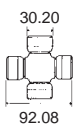

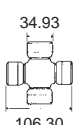
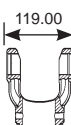

Fig 1.



Fig 2.

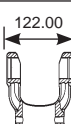

Fig 3.

Shaft Identification			Weld-in Tube Yoke Fig 1.	Splined Sleeve Fig 2.	Inner Bar Yoke Fig 3.	Inner Spline Bar to Suit
Series	U/Joint Size	Nominal Yoke Width				
4	26.99  74.61	83.00 	E40-014-003#	E40-014-249#	E40-014-250#	E40-140-611# 30mm x 10Spl 780mm
6	30.20  92.08	106.00 	E60-016-035#	E60-016-032#	E60-016-031#	E60-150-715# 35mm x 12Spl 765mm
8	34.93  106.30	119.00 	E80-018-144	E80-018-014	E80-018-145	E80-170-688 40mm x 14Spl 735mm
9	41.00  108.00	122.00 	E90-019-055	E90-019-056	E90-019-054	E90-190-617 45mm x 16Spl 730mm

European PTO

INDENT ITEM ONLY

B:7-38

www.walterscheid.com.au

Document No:	SABRECAT
Issue:	1
Issue Date:	20/04/2019

This catalogue is the copyright
of HS Company Pty Ltd

European PTO

'D' SERIES SPLINES & YOKES

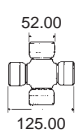
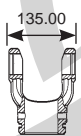

Fig 1.

Shaft Identification			Universal Joint	Splined Sleeve	Inner Bar Yoke Fig 1.	Inner Spline Bar to Suit
Series	U/Joint Size	Nominal Yoke Width				
120			K5-A780	NSS	D120-120-003#	D120-100-002# 50mm x 24 Spl 750mm

D120 SERIES SPLINED YOKES



Fig 1.



Fig 2.

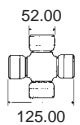
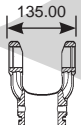

Fig 3.

Shaft Identification			Universal Joint	1 3/4 6 Spline QR (Pin Type) Fig 1.	1 3/4 20 Spline QR (Collar Type) Fig 2.	1 3/4 20 Spline PB Fig 3.
Series	U/Joint Size	Nominal Yoke Width				
120			K5-A780	D120-220-005	D120-220-001	D120-220-038

www.walterscheid.com.au

Document No:	SABRECAT
Issue:	1
Issue Date:	20/04/2019

This catalogue is the copyright of HS Company Pty Ltd

INDENT ITEM ONLY

WIDE ANGLE 'T' SERIES TRI LOBE TUBE YOKES



Shaft Identification			Outer Tube Yoke	Outer To Suit Inner Rilsan Coated Tube	Inner Tube Yoke	Inner Tube Rilsan Coated
Series	U/Joint Size	Nominal Yoke Width				
2			T20-022-166#		T20-022-172#	
4			T40-024-263		T40-024-269#	
6			T60-026-229		T60-026-249#	
8			T80-028-152		T80-028-165	

Note: Rilsan coated tube used on wide angle shafts.

European PTO

INDENT ITEM ONLY

B:7-40

www.walterscheid.com.au

Document No:	SABRECAT
Issue:	1
Issue Date:	20/04/2019

This catalogue is the copyright of HS Company Pty Ltd

European PTO

WIDE ANGLE 'V' SERIES MULTI LOBE TUBE YOKES



Shaft Identification			Outer Tube Yoke	Outer To Suit Inner Rilsan Coated Tube	Inner Tube Yoke	Inner Tube Rilsan Coated
Series	U/Joint Size	Nominal Yoke Width				
2			V20-022-325#		V20-022-326#	
4			V40-024-433#		V40-024-434#	
6			V60-026-390		V60-026-391	
8			V80-028-248		V80-028-249	

Note: Rilsan coated tube used on wide angle shafts.

www.walterscheid.com.au











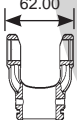
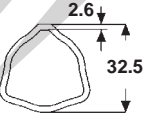
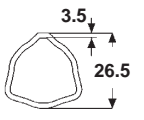

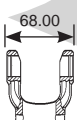
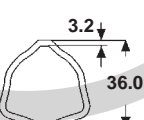

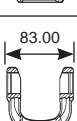
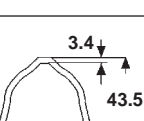
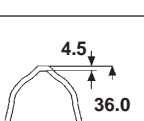

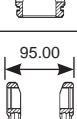
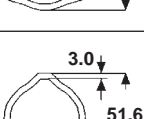
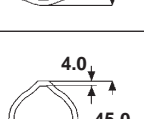

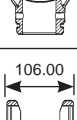
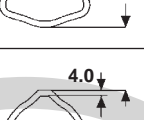
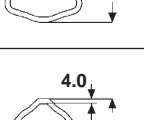

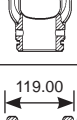

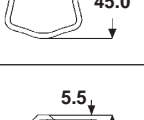
Document No:	SABRECAT
Issue:	1
Issue Date:	20/04/2019

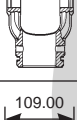
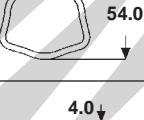
This catalogue is the copyright of HS Company Pty Ltd

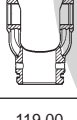
INDENT ITEM ONLY

'T' SERIES TRI-LOBE TUBE

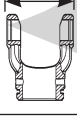
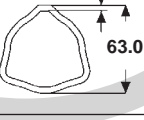

Shaft Identification			Outer Tube	Outer Tube Dimensions	Inner Tube	Inner Tube Dimensions
Series	U/Joint Size	Nominal Yoke Width				
1	22.00  54.00	62.00 	191-110-200	 2.6 32.5	191-110-100	 3.5 26.5
2	23.80  61.30	68.00 	191-120-200	 3.2 36.0	191-120-100	 4.0 29.0
4	26.99  74.61	83.00 	191-130-200	 3.4 43.5	191-140-100	 4.5 36.0
5	30.20  80.00	95.00 	191-150-200	 3.0 51.6	191-150-100	 4.0 45.0
6	30.20  92.08	106.00 	191-160-200	 4.0 54.0	191-150-100	 4.0 45.0
7	30.20  106.30	119.00 	191-160-200	 4.0 54.0	191-170-100	 5.5 45.0
7N	35.00  94.00	109.00 	191-160-200	 4.0 54.0	191-170-100	 5.5 45.0
8	34.93  106.30	119.00 	191-198-850	 4.0 63.0	191-190-300	 5.0 54.0
9	41.00  108.00	122.00 	191-198-850	 4.0 63.0	191-190-300	 5.0 54.0

European PTO

www.walterscheid.com.au

Document No:	SABRECAT
Issue:	1
Issue Date:	20/04/2019



This catalogue is the copyright of HS Company Pty Ltd

INDENT ITEM ONLY

European PTO

'V' SERIES MULTI-LOBE TUBE

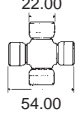
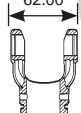
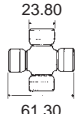
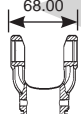
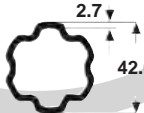
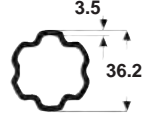
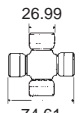
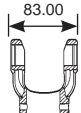
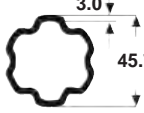
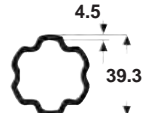
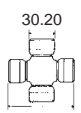
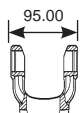

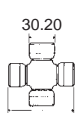
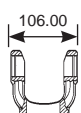
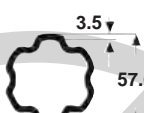
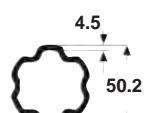
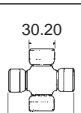
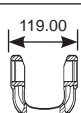
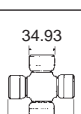
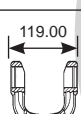
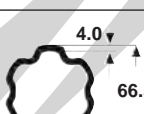
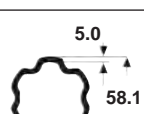
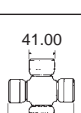
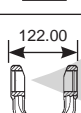
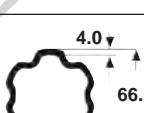
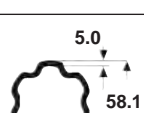
Shaft Identification			Outer Tube	Outer Tube Dimensions	Inner Tube	Inner Tube Dimensions
Series	U/Joint Size	Nominal Yoke Width				
1	 22.00 54.00	 62.00	-	-	-	-
2	 23.80 61.30	 68.00	191-120-800	 2.7 42.0	191-120-700	 3.5 36.2
4	 26.99 74.61	 83.00	191-140-800	 3.0 45.7	191-140-700	 4.5 39.3
5	 30.20 80.00	 95.00	191-160-800	 3.5 57.6	191-160-700	 4.5 50.2
6	 30.20 92.08	 106.00	191-160-800	 3.5 57.6	191-160-700	 4.5 50.2
7	 30.20 106.30	 119.00	-	-	-	-
8	 34.93 106.30	 119.00	191-190-800	 4.0 66.5	191-190-700	 5.0 58.1
9	 41.00 108.00	 122.00	191-190-800	 4.0 66.5	191-190-700	 5.0 58.1

www.walterscheid.com.au







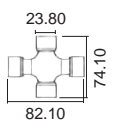

Document No:	SABRECAT
Issue:	1
Issue Date:	20/04/2019

This catalogue is the copyright of HS Company Pty Ltd

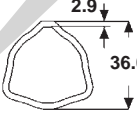
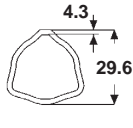
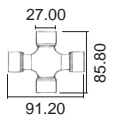
INDENT ITEM ONLY

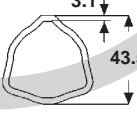
WIDE ANGLE 'T' SERIES TRI-LOBE TUBE

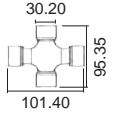
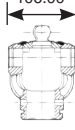
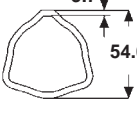
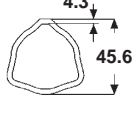
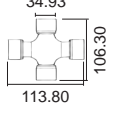
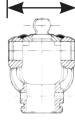
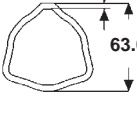

Shaft Identification			Outer To Suit Inner Rilsan Coated Tube	Outer Tube Dimensions	Inner Tube Rilsan Coated	Inner Tube Dimensions
Series	U/Joint Size	Nominal Yoke Width				
2			191-120-500#		152-120-261# Rilsan Coated 1300mm Long	
4			191-140-500		152-140-577# Rilsan Coated 1280mm Long	
6			191-160-500		152-160-847# Rilsan Coated 1265mm Long	
8			191-180-500		152-190-529# Rilsan Coated 1235mm Long	

Note: Rilsan coated tube used on wide angle shafts.

European PTO

INDENT ITEM ONLY

B:7-44

www.walterscheid.com.au



Document No:	SABRECAT
Issue:	1
Issue Date:	20/04/2019

This catalogue is the copyright of HS Company Pty Ltd

European PTO

WIDE ANGLE 'V' SERIES MULTI-LOBE TUBE

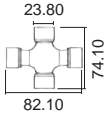
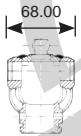
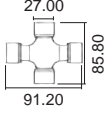

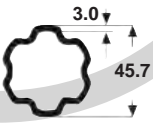
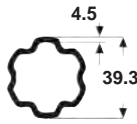
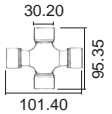
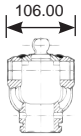
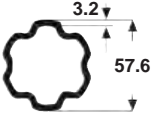
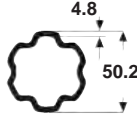
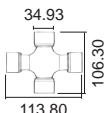
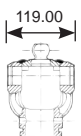
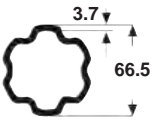
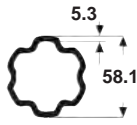
Shaft Identification			Outer To Suit Inner Rilsan Coated Tube	Outer Tube Dimensions	Inner Tube Rilsan Coated	Inner Tube Dimensions
Series	U/Joint Size	Nominal Yoke Width				
2	 23.80 74.10 82.10	 68.00	-	-	-	-
4	 27.00 85.80 91.20	 83.00	191-140-850	 3.0 45.7	159-240-018 Nitrated Tube 1380mm Long	 4.5 39.3
6	 30.20 96.35 101.40	 106.00	191-160-850	 3.2 57.6	159-260-179 Rilsan Coated 1365mm Long	 4.8 50.2
8	 34.93 106.30 113.80	 119.00	191-190-850	 3.7 66.5	159-280-125 Rilsan Coated 1335mm Long	 5.3 58.1

Note: Rilsan coated tube used on wide angle shafts.

www.walterscheid.com.au

Document No:	SABRECAT
Issue:	1
Issue Date:	20/04/2019

INDENT ITEM ONLY

FM TYPE FRICTION DISC CLUTCH

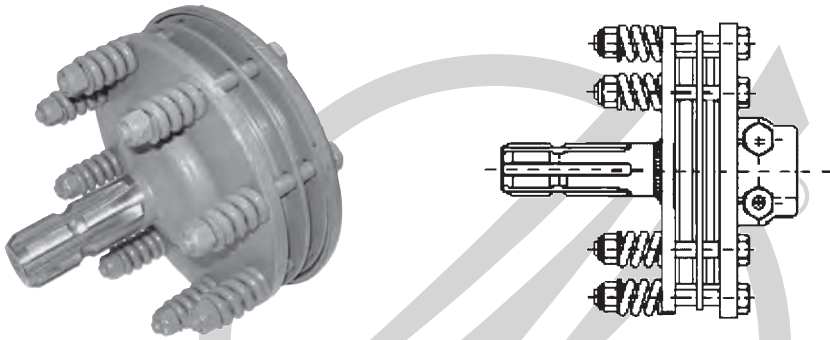

Ratings			Male Spline Details	F/Male Spline Details	Complete Unit Part Number	Length E-E		OD	
540 RPM	1000 RPM	Torque				mm	inch	mm	inch
50 Hp	90 Hp	480 ft.lb 650 Nm	1 3/8" x 6	1 3/8" x 6	FM-231-003	189	7.441	150	5.905
				1 3/8" x 21					
65 Hp	125 Hp	665 ft.lb 900 Nm	1 3/8" x 6	1 3/8" x 6	FM-241-006	207	8.149	180	7.086
				1 3/8" x 21					
90 Hp	165 Hp	885 ft.lb 1500 Nm	1 3/8" x 6	1 3/8" x 6	FM-252-009	209	8.228	180	7.086
				1 3/8" x 21					
120 Hp	188 Hp	1475 ft.lb 2400 Nm	1 3/8" x 6	1 3/8" x 6	FM-264-005	209	8.228	200	7.874
				1 3/8" x 21					
			1 3/4" x 6	1 3/4" x 6	FM-284-001				
			1 3/4" x 20	1 3/4" x 20	FM-284-002				

European PTO

INDENT ITEM ONLY

B:7-46

www.walterscheid.com.au

Document No:	SABRECAT
Issue:	1
Issue Date:	20/04/2019

This catalogue is the copyright of HS Company Pty Ltd

FM TYPE FRICTION DISC CLUTCH

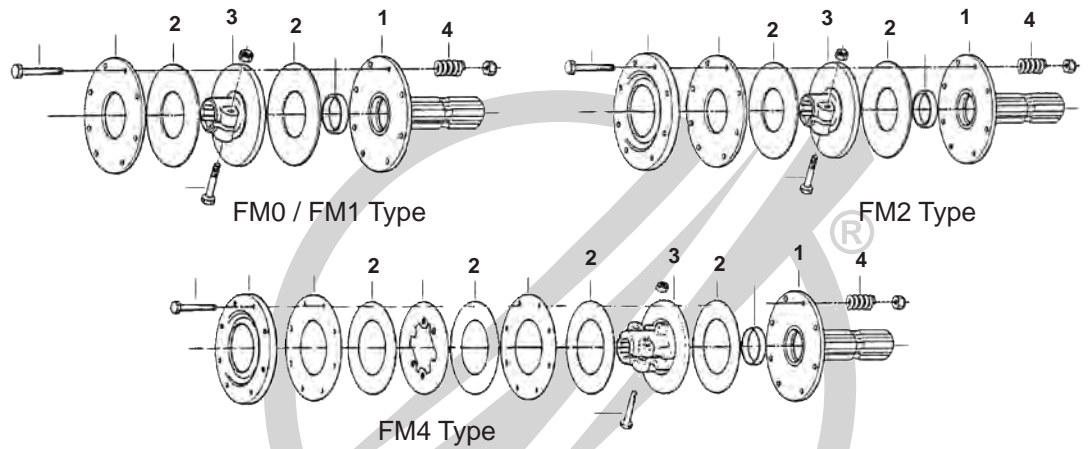

Series	Ref.	Male shaft Face 1	Clutch Lining 2	Lining Dia. mm OD / ID		Hub 3	Spring 4
2	FM02	F02-013-051#	F02-014-019	120	68	F02-014-018#	F12-014-022
						F02-013-022#	
4	FM12	F12-013-055#	F12-015-019	142	77.5	F12-015-018#	F12-014-022
						F12-015-010#	
6	FM22	F22-019-060#	F42-019-018	152	90	F22-018-018#	F22-019-017
						F22-017-013#	
8	FM42	F42-019-060#	F42-019-018	152	90	F42-019-011#	F12-014-022
						F42-019-008#	
						F42-019-012#	
						F42-019-009	

Call Walterscheid Australia for further details on clutch spare parts

www.walterscheid.com.au



Document No:	SABRECAT
Issue:	1
Issue Date:	20/04/2019

This catalogue is the copyright of HS Company Pty Ltd

INDENT ITEM ONLY

F TYPE FRICTION DISC CLUTCH

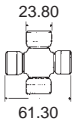
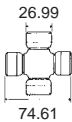
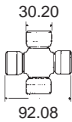
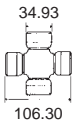

Series	U/Joint Size	Ref.	Spline Details	Part Number	Maximum Torque		Length C-E		OD	
					Nm	in.lb	mm	inch	mm	inch
2		F02	1 3/8" x 6	T20-221-001	650	5750	120	4.724	153	6.024
		F03	1 3/8" x 21	T20-221-002#						
4		F02	1 3/8" x 6	T40-241-002	900	7950	135	5.315	180	7.086
		F12	1 3/8" x 6	T40-241-001						
		F13	1 3/8" x 21	T40-241-003#						
6		F22	1 3/8" x 6	T60-261-001	1200	10620	146	5.748	195	7.677
		F42	1 3/8" x 6	T60-264-001	1600	14150	156	6.142		
8		F42	1 3/8" x 6	T80-284-001	2000	17700	169	6.654	195	7.677
		F44	1 3/4" x 6	T80-284-013						
		F45	1 3/4" x 20	T80-284-004						
9		F42	1 3/8" x 6	T90-294-011	2000	17700	169	6.654	195	7.677
		F44	1 3/4" x 6	T90-294-013#						
		F45	1 3/4" x 20	T90-294-014#						

European PTO

INDENT ITEM ONLY

B:7-48

www.walterscheid.com.au

Document No:	SABRECAT
Issue:	1
Issue Date:	20/04/2019

This catalogue is the copyright of HS Company Pty Ltd

European PTO

F TYPE FRICTION DISC CLUTCH

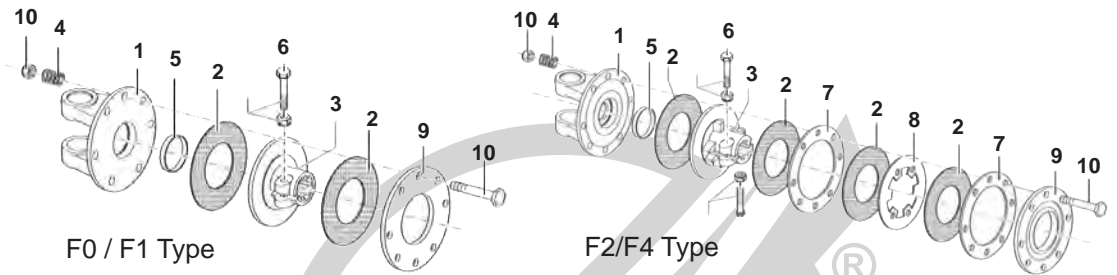

F0 / F1 Type

F2/F4 Type

Components suit original Comer clutches only.

Series	Ref.	Flange Yoke 1	Clutch Lining 2	Lining Dia. mm OD / ID		Hub 3	Spring 4
2	F02	T20-012-139#	F02-014-019	120	68	F02-014-570#	F12-014-022
	F03					F02-014-592#	
4	F02	T40-014-017#	F02-014-019	120	68	F02-014-570#	F12-014-022
	F12	T40-014-009	F12-015-019	142	77.5	F12-015-018	F12-014-022
	F13					F12-015-010#	
6	F22	T60-016-037	F42-019-018	152	90	F22-018-018	F12-014-017
	F42	T60-016-037	F42-019-018	152	90	F42-019-011	F12-014-017
8	F42	T80-018-016	F42-019-018	152	90	F42-019-011	F12-014-022
	F44					F42-019-012	
	F45					F42-019-009	
9	F42	T90-019-059#	F42-019-018	152	90	F42-019-011	F12-014-022
	F44					F42-019-012	
	F45					F42-019-009	

EXTRA INTERNAL SPARE PARTS FOR DISC CLUTCHES

Clutch Type	Bush 5	Bolt Kit 6	Inner Plate 7	Intermediate Plate 8	Pressure Plate 9	Bolt Kit 10
F0 / F1	F12-015-020	165-000-502 <i>suit 1-3/8" spl hubs</i>			F12-015-021	165-000-501
F2 / F4	F42-019-019	165-000-502 <i>suit 1-3/8" spl hubs</i>	F42-019-014	F42-019-115	F42-019-116	165-000-548
		165-000-503 <i>suit 1-3/4" spl hubs</i>				

www.walterscheid.com.au

Document No:	SABRECAT
Issue:	1
Issue Date:	20/04/2019

This catalogue is the copyright of HS Company Pty Ltd

Call Walterscheid Australia for further details on clutch spare parts

INDENT ITEM ONLY

SHEAR BOLT TORQUE LIMITER

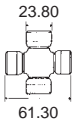
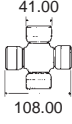

Series	U/Joint Size	Ref.	Splines Details	Part Number	Maximum Torque		Length C-E	
					Nm	in.lb	mm	inch
2	 23.80 61.30	B02	1 3/8" x 6	T20-220-001#	650	5700	95	3.740
		B03	1 3/8" x 21	T20-220-002#				
4	 26.99 74.61	B02	1 3/8" x 6	T40-240-001#	1700	15000	97	3.819
		B03	1 3/8" x 21	T40-240-002#				
6	 30.20 92.08	B02	1 3/8" x 6	T60-260-001	2500	22100	137	5.394
		B03	1 3/8" x 21	T60-260-003#				
		B04	1 3/4" x 6	T60-260-002#				
		B05	1 3/4" x 20	T60-260-004#				
8	 34.93 106.30	B02	1 3/8" x 6	T80-280-001	3500	30900	146	5.748
		B03	1 3/8" x 21	T80-280-003#				
		B04	1 3/4" x 6	T80-280-002#				
		B05	1 3/4" x 20	T80-280-004				
9	 41.00 108.00	B02	1 3/8" x 6	T90-290-001#	4000	35400	152	5.984
		B03	1 3/8" x 21	T90-290-003#				
		B04	1 3/4" x 6	T90-290-002#				
		B05	1 3/4" x 20	T90-290-004#				

European PTO

INDENT ITEM ONLY

B:7-50

www.walterscheid.com.au

Document No:	SABRECAT
Issue:	1
Issue Date:	20/04/2019

This catalogue is the copyright of HS Company Pty Ltd

European PTO

SHEAR BOLT TORQUE LIMITER PARTS

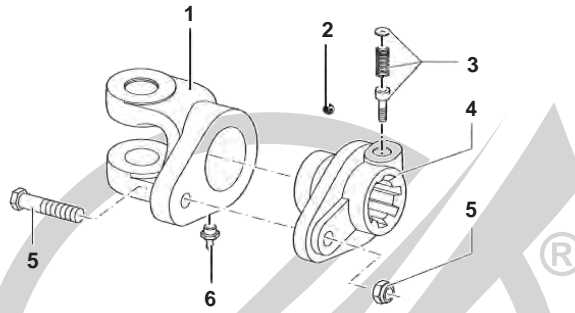

Series	Ref.	Yoke 1	Ball 2	QR Push Pin Set 3	Splined Hub 4	Bolt & Nut 5	Grease Nipple 6
2	B02	T20-012-005#	190-000-024# 7/32" DIA (24 Req)	165-026-004	T20-022-010#	165-000-509# M6x40 (ISO 8.8)	M8x1
	B03				T20-022-017#		
4	B02	T40-014-012#	190-000-022# 1/4" DIA (23 Req)	165-026-004	T40-024-013#	165-000-505# M8x50 (ISO 8.8)	M8x1
	B03				T40-024-026#		
6	B02	T60-016-042#	190-000-023# 5/16" DIA (24 Req)	165-026-004	T60-026-043#	165-000-507# M10x60 (ISO 8.8)	M10x1
	B03				T60-026-026#		
	B04			166-026-005	T60-026-044#		
	B05				T60-026-027#		
8	B02	T80-018-023#	190-000-023# 5/16" DIA (24 Req)	165-026-004	T80-028-024#	165-000-512# M12x65 (ISO 8.8)	M10x1
	B03				T80-028-037#		
	B04			166-026-005	T80-028-025#		
	B05				T80-028-038#		
9	B02	T90-019-136#	190-000-023# 5/16" DIA (24 Req)	165-026-004	T90-029-137#	165-000-512# M12x65 (ISO 8.8)	M10x1
	B03				T90-029-142#		
	B04			166-026-005	T90-029-141#		
	B05				T90-029-140#		

www.walterscheid.com.au



Document No:	SABRECAT
Issue:	1
Issue Date:	20/04/2019

This catalogue is the copyright of HS Company Pty Ltd

INDENT ITEM ONLY

OVERLOAD RATCHET CLUTCHES

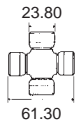
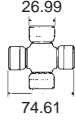

Series	U/Joint Size	Ref.	Spline Details	Part Number	Maximum Torque		Length C-E	
					Nm	in.lb	mm	inch
2	 23.80 61.30	U24	1 3/8" x 6	T20-226-001	600	5310	146	5.748
4	 26.99 74.61	U34	1 3/8" x 6	T40-246-001	900	7965	185	7.283
6	 30.20 92.08	U44	1 3/8" x 6	T60-266-029	1200	10620	220	8.66

European PTO

INDENT ITEM ONLY

B:7-52

www.walterscheid.com.au

Document No:	SABRECAT
Issue:	1
Issue Date:	20/04/2019

This catalogue is the copyright of HS Company Pty Ltd

European PTO

OVERRUNNING CLUTCH

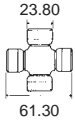
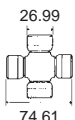
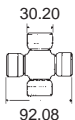
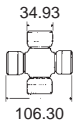

Series	U/Joint Size	Ref.	Splines Details	Part Number	Maximum Torque		Length C-E	
					Nm	in.lb	mm	inch
2		R12	1 3/8" x 6	T20-225-001#	3800	33630	146	5.748
		R13	1 3/8" x 21	T20-225-002#				
4		R12	1 3/8" x 6	T40-245-001	3800	33630	157	6.181
6		R12	1 3/8" x 6	T60-265-001	3800	33630	167	6.575
		R13	1 3/8" x 21	T60-265-004	3800	33630	167	6.575
8		R12	1 3/8" x 6	T80-285-001	3800	33630	176	6.929
		R13	1 3/8" x 21	T80-285-002	3800	33630	176	6.929

Call Walterscheid Australia for further details on overrunning clutch spare parts

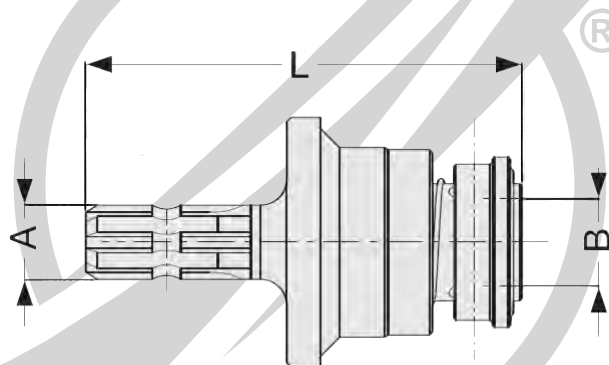

Ref	Splines Details A (Male)	Splines Details B (Female)	Part Number	Maximum Torque		Length L	
				Nm	in.lb	mm	inch
RM	1 3/8" x 6	1 3/8" x 6	RM-215-015	3800	33630	208	8.188

INDENT ITEM ONLY

www.walterscheid.com.au	
Document No:	SABRECAT
Issue:	1
Issue Date:	20/04/2019

ALL PURPOSE TYPE COVER SET

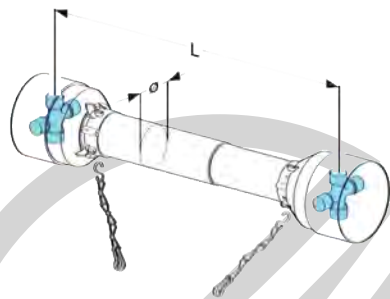

Series	Inner Bearing ID	Outer Bearing ID	Length	Complete Cover Set
10	34mm	40mm	1500mm	AGC10-100-1500
20	40mm	46mm	1500mm	AGC20-200-1500
30	47mm	54mm	1500mm	AGC40-400-1500
40	47mm	54mm		
50	54.5mm	62.5mm		-
60	60mm	69mm	1500mm	AGC60-600-1500
7N	60mm	69mm		
70	60mm	69mm		
80	69.5mm	81.5mm	1500mm	AGC80-800-1500
90	69.5mm	81.5mm		

European PTO

INDENT ITEM ONLY

B:7-54

www.walterscheid.com.au

Document No:	SABRECAT
Issue:	1
Issue Date:	20/04/2019

This catalogue is the copyright of HS Company Pty Ltd

European PTO

ORIGINAL COMER TYPE COVER SET

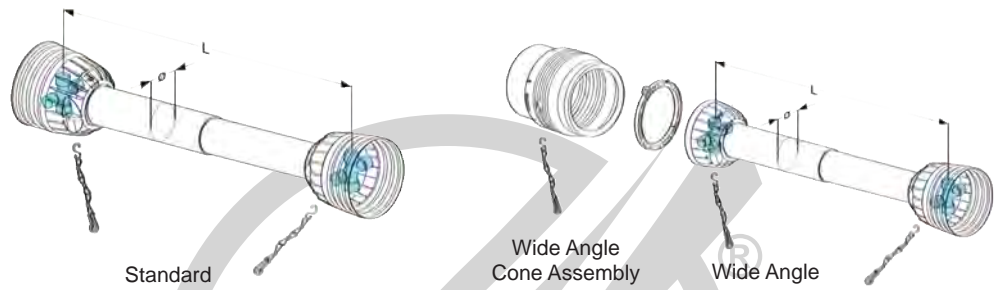

Series	Inner Guard Bearing	Outer Guard Bearing	Complete Cover Set		Wide Angle Cone Assy	Complete Cover Set Wide Angle
10	180-011-343 (34mm ID)	180-011-342 (40mm ID)	142-310-016		-	-
20	180-012-381 (40mm ID)	180-012-380 (46mm ID)	142-320-033		165-000-760	142-721-516
40	180-014-506 (47mm ID)	180-014-505 (54mm ID)	142-340-047		165-000-754	142-741-516
50	180-015-390 (54.5mm ID)	180-015-391 (62.5mm ID)	142-360-019		-	-
60	180-016-595 (60mm ID)	180-016-596 (69mm ID)	142-360-019		165-000-750	142-761-518
80	180-019-354 (69.5mm ID)	180-019-353 (81.5mm ID)	142-380-048		165-000-753	142-781-516
90	180-019-354 (69.5mm ID)	180-019-353 (81.5mm ID)	142-380-048		-	-

www.walterscheid.com.au

Document No:	SABRECAT
Issue:	1
Issue Date:	20/04/2019

This catalogue is the copyright of HS Company Pty Ltd

INDENT ITEM ONLY