

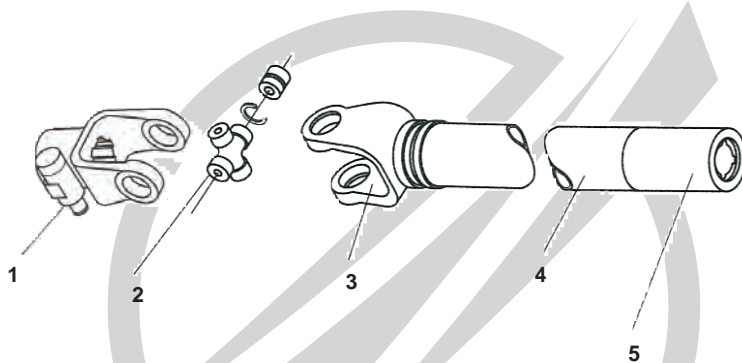









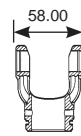

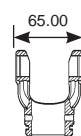
**NORTH AMERICAN SERIES OUTER SHAFT PARTS**

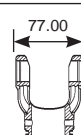

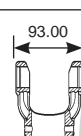
Shaft Identification			QR Yoke 1 3/8 x 6 Collar Type 1	Universal Joint 2	Weld-in Tube Yoke 3	Tube Size 4	Drive Nib 5
Series	U/Joint Size	Nominal Yoke Width					
<b>06</b>	24.61  36.80	 58.00	<b>06-100-0606</b>	<b>4062000</b> <i>(114-1004)</i>	<b>06-701-0600</b>	<b>06-604-0600</b> 1 1/2" x .065"	<b>06-510-0600</b> 3/4" x 7/8"
<b>12</b>	26.99  46.04	 65.00	<b>12-102-1206</b>	<b>4122000</b> <i>(RUJ-1788)</i>	<b>12-701-1200</b>	<b>1614-0000</b> 2" x .083"	<b>14-500-1400</b> 1" x 1 1/8"
<b>14</b>	28.58  66.67	 77.00	<b>14-100-1406</b>	<b>4142000</b> <i>(CPL14N)</i>	<b>14-701-1400</b>	<b>1614-0000</b> 2" x .083"	<b>4-500-1400</b> 1" x 1 1/8"
<b>35</b>	31.75  81.36	 93.00	<b>35-101-3506</b>	<b>4352000</b> <i>(CP35N-3)</i>	<b>35-701-3500</b>	<b>1711-0000</b> 2 1/8" x .120"	<b>35-500-3500</b> 1 3/16" x 1 3/16"
<b>44</b>	33.35  70.64	 108.00	<b>44-101-4406</b>	<b>4442000</b> <i>(RUJ-3009)</i>	<b>44-702-4400</b>	<b>2011-0000</b> 2 1/2" x .120"	<b>44-500-4400</b> 1 5/16" x 1 5/16"
<b>55</b>	38.89  109.60	 121.00	<b>55-101-5506</b>	<b>4552000</b> <i>(CP55N)</i>	<b>55-704-5500</b>	<b>2011-0000</b> 2 1/2" x .120"	<b>44-500-4400</b> 1 5/16" x 1 5/16"

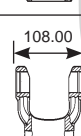
Note: Other yokes and drive bar variations available

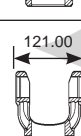
# INDENT ITEM ONLY

B:7-56

North American PTO

www.walterscheid.com.au

Document No:	SABRECAT
Issue:	1
Issue Date:	20/04/2019

This catalogue is the copyright of HS Company Pty Ltd

## NORTH AMERICAN SERIES INNER SHAFT PARTS

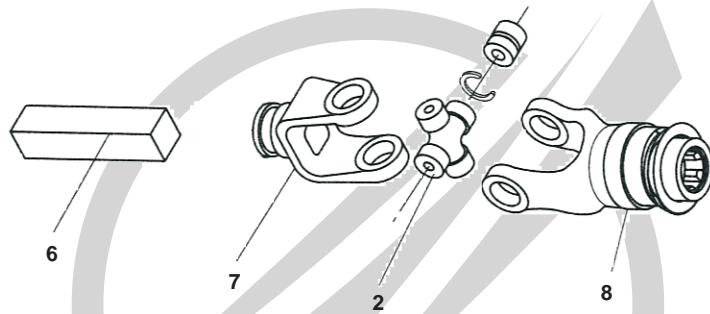

Shaft Identification			Inner Bar 36" Long 6	Inner Bar Yoke 7	QR Yoke 1 3/8 x 6 Collar Type 8	Cover Guard Bearing Kit 9	Cover Guard 10
Series	U/Joint Size	Nominal Yoke Width					
06	24.61  36.80	58.00 	06-404-1214 3/4" x 7/8"	06-300-0600# 3/4" x 7/8"	06-100-0606	921-0600	900-2560 60" Long
12	26.99  46.04	65.00 	14-404-1618 1" x 1 1/8"	12-300-1200 1" x 1 1/8"	12-102-1206	921-1200	900-2560 60" Long
14	28.58  66.67	77.00 	14-404-1618 1" x 1 1/8"	14-300-1400 1" x 1 1/8"	14-100-1406	921-1200	900-2560 60" Long
35	31.75  81.36	93.00 	35-404-0019 1 3/16" Square	35-300-3500 1 3/16" Square	35-101-3506	921-1200	900-2560 60" Long
44	33.35  70.64	108.00 	44-404-0021 1 5/16" Square	44-300-4400 1 5/16" Square	44-101-4406	921-4400	902-3560 60" Long
55	38.89  109.60	121.00 	44-404-0021 1 5/16" Square	55-300-5500 1 5/16" Square	55-101-5506	921-4400	902-3560 60" Long

Note: Other yokes and drive bar variations available

# INDENT ITEM ONLY





www.walterscheid.com.au

Document No:	SABRECAT
Issue:	1
Issue Date:	20/04/2019

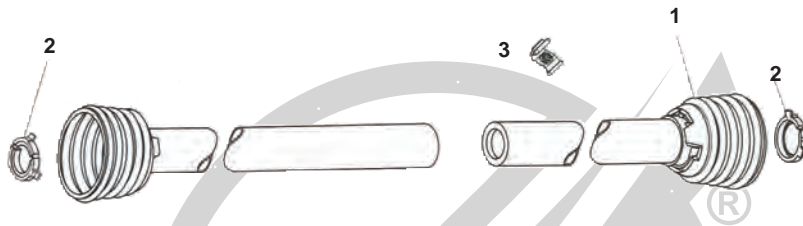
This catalogue is the copyright of HS Company Pty Ltd

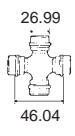
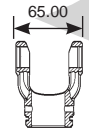
**NORTH AMERICAN SERIES COVER SET**

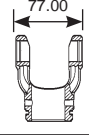
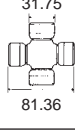
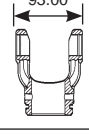
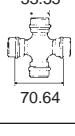
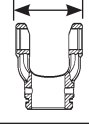

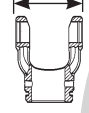
Shaft Identification			Cover Guard 1	Length	Cover Guard Bearing Kit (2 per Kit) 2	Easy Lock Retainer Clips (4 per Kit) 3
Series	U/Joint Size	Nominal Yoke Width				
12	 26.99 46.04	 65.00	900-2560	60" 1524mm	921-1200	13005000#
14	 28.58 66.67	 77.00	900-2560	60" 1524mm	921-1200	
35	 31.75 81.36	 93.00	900-2560	60" 1524mm	921-1200	
44	 33.35 70.64	 108.00	902-3560	60" 1524mm	921-4400	
55	 38.89 109.60	 121.00	902-3560	60" 1524mm	921-4400	

North American PTO

# INDENT ITEM ONLY

B:7-58



www.walterscheid.com.au

Document No:	SABRECAT
Issue:	1
Issue Date:	20/04/2019

This catalogue is the copyright of HS Company Pty Ltd

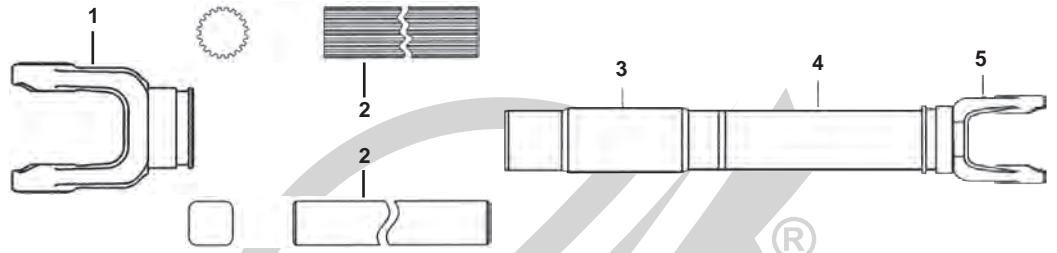
## NORTH AMERICAN SERIES SHAFT VARIATIONS

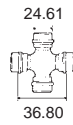
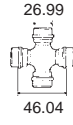
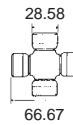
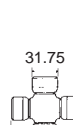

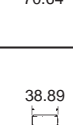
Shaft Identification			Bar Yoke	Drive Bar	Drive Nib	Drive Tube	Weld Yoke
Series	U/Joint Size	Drive Bar Dimension	1	2	3	4	5
06	 24.61 36.80	1" x 15 Spline	06-302-0600	06-404-1615H 36" Long	06-510-0615	06-604-0600 1.5" x .065"	06-702-0600 (No Groove)  06-701-0600 (Groove)
			12	 26.99 46.04	1" x 1 1/8"	12-300-1200	14-404-1618 36" Long
	12-300-1200	14-404-1618 36" Long	N/A			12-604-2022# 1 1/4" x 1 3/8" 36" Long	12-700-1200#
14	 28.58 66.67	1" x 1 1/8"	14-300-1400	14-404-1618 36" Long	14-500-1400	1614-0000 2" x .083"	14-701-1400
		1 5/16" x 20 Spline	14-301-1400#	35-404-2120 36" Long	35-501-1400	1711-0000 2 1/8" x .120"	14-701-1400
35	 31.75 81.36	1 3/16" Square	35-300-3500	35-404-0019 36" Long	35-500-3500	1711-0000 2 1/8" x .120"	35-701-3500
		1 5/16" x 20 Spline	35-301-3500#	35-404-2120 36" Long	35-502-3500#	1711-0000 2 1/8" x .120"	35-701-3500
		1 11/16" x 20 Spline	35-302-3500	44-404-2720 36" Long	35-503-3500	2011-0000 2 1/2" x .120"	35-704-3500# Hollow butt
44	 33.35 70.64	1 5/16" Square	44-300-4400#	44-404-0021 36" Long	44-500-4400	2011-0000 2 1/2" x .120"	44-701-4400#
		1 11/16" x 20 Spline	44-302-4400#	44-404-2720 36" Long	35-503-3500	2011-0000 2 1/2" x .120"	44-702-4400 Hollow butt
55	 38.89 109.60	1 5/16" Square	55-300-5500	44-404-0021 36" Long	44-500-3500	2011-0000 2 1/2" x .120"	55-701-5500#
		1 11/16" x 20 Spline	55-302-5500	44-404-2720 36" Long	35-503-3500	2011-0000 2 1/2" x .120"	55-704-5500 Hollow butt

www.walterscheid.com.au

Document No:	SABRECAT
Issue:	1
Issue Date:	20/04/2019

This catalogue is the copyright of HS Company Pty Ltd

# INDENT ITEM ONLY

**NORTH AMERICAN QUICK RELEASE YOKES**

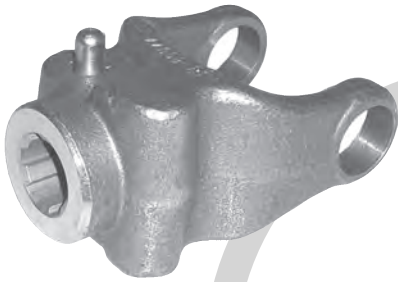
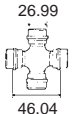

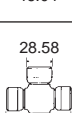
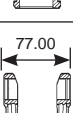
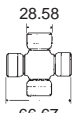
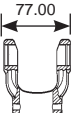
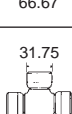
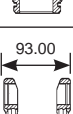
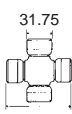
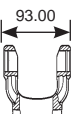

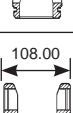
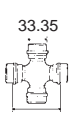
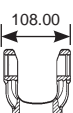
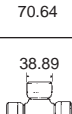
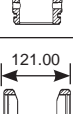
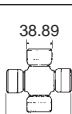
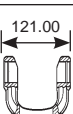
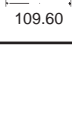
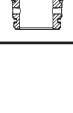

Fig 1.  
Push Pin Type



Fig 2.  
Collar Type

Shaft Identification			Fig Ref.	1 3/8 6 Spline	1 3/8 21 Spline	1 3/4 6 Spline	1 3/4 20 Spline	1 1/8 HEX
Series	U/Joint Size	Nominal Yoke Width						
12	 26.99	 65.00	1	12-102-1206	12-102-1221	-	-	-
	 46.04	 65.00	2	12-100-1206#	12-100-1221#	-	-	-
14	 28.58	 77.00	1	14-102-1406#	14-102-1421#	-	-	14-102-1418
	 66.67	 77.00	2	14-100-1406	14-100-1421	-	14-101-1420#	-
35	 31.75	 93.00	1	35-102-3506#	35-102-3521#	35-102-3528#	35-102-3520	35-102-3518
	 81.36	 93.00	2	35-101-3506	35-101-3521	-	35-101-3520	-
44	 33.35	 108.00	1	44-102-4406#	44-102-4421#	-	44-102-4420#	-
	 70.64	 108.00	2	44-101-4406	44-101-4421	-	44-101-4420	-
55	 38.89	 121.00	1	55-102-5506#	55-102-5521#	55-102-5528#	55-102-5520#	-
	 109.60	 121.00	2	55-101-5506	55-101-5521	-	55-101-5520	-

North American PTO

# INDENT ITEM ONLY

B:7-60



www.walterscheid.com.au

Document No:	SABRECAT
Issue:	1
Issue Date:	20/04/2019

This catalogue is the copyright of HS Company Pty Ltd

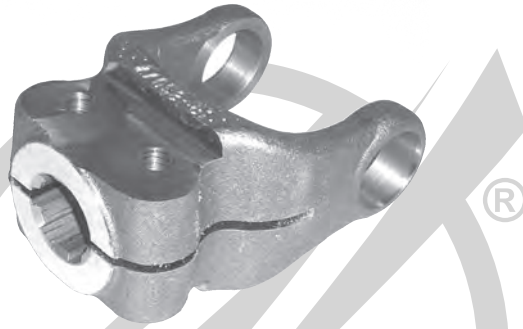
## NORTH AMERICAN PINCH BOLT YOKES

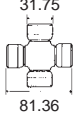
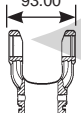
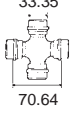
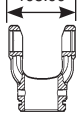
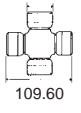

Shaft Identification			1 3/8 6 Spline	1 3/8 21 Spline	1 3/4 20 Spline	1 3/4 27 Spline
Series	U/Joint Size	Nominal Yoke Width				
35	 31.75 81.36	 93.00	-	35-807-3521#	35-807-3520	35-807-3527#
44	 33.35 70.64	 108.00	44-807-4406	44-807-4421	44-807-4420	44-807-4427#
55	 38.89 109.60	 121.00	55-807-5506	55-807-5521	55-807-5520	55-807-5527#

www.walterscheid.com.au





Document No:	SABRECAT
Issue:	1
Issue Date:	20/04/2019

This catalogue is the copyright  
of HS Company Pty Ltd

# INDENT ITEM ONLY

NORTH AMERICAN BORE & KEY YOKES



Shaft Identification		Pilot Bore No Key	3/4" Bore 3/16" Key	1" Bore 1/4" Key	1 1/4" Bore 1/4" Key	1 1/4" Bore 5/16" Key
Series	U/Joint Size					
12	26.99  46.04	12-809-1208  1/2" Bore	12-800-1212#	12-1135 LENGTH=2.750"	12-800-1220#	12-1139 LENGTH=2.750"
				12-4-1115 LENGTH=3.500"		12-4-1119 LENGTH=3.500"
14	28.58  66.67	14-809-1412  3/4" Bore	-	14-800-1416#	14-800-1420#	-
35	31.75  81.36	35-809-3516  1" Bore	-	35-800-3516#	35-800-3520#	-
44	33.35  70.64	44-809-4416  1" Bore	-	-	44-800-4420#	-
55	38.89  109.60	55-809-5516#  1" Bore	-	-	-	-

North American PTO

# INDENT ITEM ONLY

B:7-62

www.walterscheid.com.au

Document No:	SABRECAT
Issue:	1
Issue Date:	20/04/2019

This catalogue is the copyright of HS Company Pty Ltd

## NORTH AMERICAN BORE & KEY YOKES



Shaft Identification		1 3/8" Bore 5/16" Key	1 1/2" Bore 3/8" Key	1 5/8" Bore 3/8" Key	1 3/4" Bore 3/8" Key	2" Bore 1/2" Key
Series	U/Joint Size					
12		12-800-1222#	12-800-1224#	-	-	-
14		14-800-1422#	14-800-1424#	-	-	-
35		35-800-3522#	35-800-1424#	35-800-3526#	35-800-3528	-
44		44-800-4422#	44-800-4424#	44-800-4426#	44-800-4428#	44-800-4432#
55		55-800-5522#	55-800-5524#	55-800-5526#	55-800-5528#	55-800-5532#

www.walterscheid.com.au

Document No:	SABRECAT
Issue:	1
Issue Date:	20/04/2019



This catalogue is the copyright of HS Company Pty Ltd

# INDENT ITEM ONLY



NORTH AMERICAN SHEAR CLUTCH

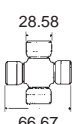
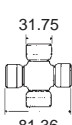

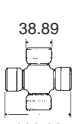
Series	U/Joint Size	Ref.	Spline Details	Part Number	Maximum Torque		Length C-E	
					Nm	in.lb	mm	inch
12	 26.99 46.04		1 3/8" x 6	12-104-1206	813	7200*	116	4.567
			1 3/8" x 21	12-104-1221#				
14	 28.58 66.67		1 3/8" x 6	14-104-1406	813	7200*	116	4.567
			1 3/8" x 21	14-104-1421#				
			1 3/4" x 20	-				
35	 31.75 81.36		1 3/8" x 6	35-104-3506	3140	27800*	141	5.551
			1 3/8" x 21	35-104-3521#			141	5.551
			1 3/4" x 20	35-104-3520#			154	6.063
44	 33.35 70.64		1 3/8" x 6	44-104-4406	3140	27800*	149	5.866
			1 3/8" x 21	44-104-4421#			149	5.866
			1 3/4" x 20	44-104-4420#			162	6.378
55	 38.89 109.60		1 3/8" x 6	55-104-5506	3140	27800*	155	6.102
			1 3/8" x 21	55-104-5521			155	6.102
			1 3/4" x 20	55-140-5520			168	6.614

\* Higher torque settings available on request

North American PTO

# INDENT ITEM ONLY

B:7-64

www.walterscheid.com.au

Document No:	SABRECAT
Issue:	1
Issue Date:	20/04/2019

This catalogue is the copyright of HS Company Pty Ltd

## NORTH AMERICAN OVERRUNNING CLUTCH



Series	U/Joint Size	Image Ref.	Spline Details	Part Number	Maximum Torque		Length C-E	
					Nm	in.lb	mm	inch
14			1 3/8" x 6	14-821-1406	1740	15400	179	7.047
			1 3/8" x 21	14-821-1421#			179	7.047
			1 3/4" x 20	14-821-1420#			189	7.441
35			1 3/8" x 6	35-820-3506	2542	22500	187	7.362
			1 3/8" x 21	35-820-3521			187	7.362
			1 3/4" x 20	35-820-3520#			197	7.756
44			1 3/8" x 6	44-821-4406	4070	36000	196	7.717
			1 3/8" x 21	44-821-4421			196	7.717
			1 3/4" x 20	44-821-4420#			206	8.110
55			1 3/8" x 6	55-821-5506	4070	36000	205	8.071
			1 3/8" x 21	55-821-5521			216	8.504
			1 3/4" x 20	55-821-5520			205	8.071

www.walterscheid.com.au

Document No:	SABRECAT
Issue:	1
Issue Date:	20/04/2019

This catalogue is the copyright of HS Company Pty Ltd

# INDENT ITEM ONLY

**NORTH AMERICAN 80° WIDE ANGLE SHAFT PARTS**  
**80° UNEQUAL U/JOINT**

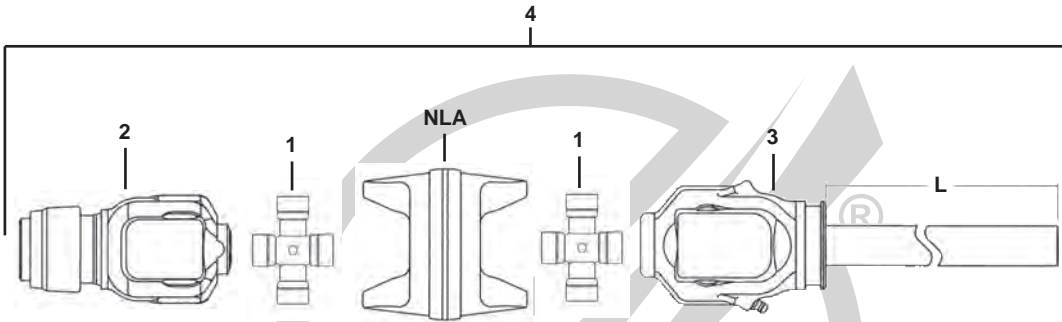

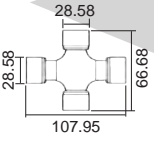
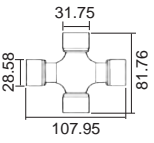
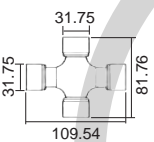
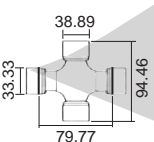
Shaft Identification		Universal Joint 1	QR Yoke Collar Type 2	Bar Yoke & Shaft 3	Half Shaft Including Cover 4
Series	U/Joint Size				
1480		<b>4142800</b> (K5-A797)	<b>14-111-1406#</b> 1 3/8 x 6Spl	<b>14-10101400#</b> 1" x 1 1/8" Shaft L=27.250"	NLA *
			<b>14-111-1421#</b> 1 3/8 x 21Spl		NLA *
			<b>14-111-1420#</b> 1 3/4 x 20Spl		-
3580		<b>4352800</b> (K5-A798)	<b>35-113-3506#</b> 1 3/8 x 6Spl	<b>35-10103501#</b> 1 5/16" x 20 Spl Shaft L=27.000"	NLA *
			<b>35-113-3521#</b> 1 3/8 x 21Spl		NLA *
			<b>35-113-3520#</b> 1 3/4 x 20Spl		NLA *
4480		<b>4442800</b> (K5-A799)	<b>35-107-3506#</b> 1 3/8 x 6Spl	<b>44-10103500#</b> 1 11/16" x 20 Spl Shaft L=27.000"	NLA *
			<b>35-107-3521#</b> 1 3/8 x 21Spl		NLA *
			<b>35-107-3520#</b> 1 3/4 x 20Spl		NLA *
5580		<b>4552800</b> (K5-A800)	<b>55-111-5506</b> 1 3/8 x 6Spl	<b>55-10105500#</b> 1 11/16" x 20 Spl Shaft L=27.000"	NLA *
			<b>55-111-5521#</b> 1 3/8 x 21Spl		NLA *
			<b>55-111-5520</b> 1 3/4 x 20Spl		NLA *

\* Note: Unequal u/joint half shaft assemblies are no longer available, equal u/joint half shaft assemblies can be used as a complete replacement.

# INDENT ITEM ONLY

B:7-66

North American PTO

www.walterscheid.com.au

Document No:	SABRECAT
Issue:	1
Issue Date:	20/04/2019

This catalogue is the copyright of HS Company Pty Ltd

## NORTH AMERICAN 50°/80° WIDE ANGLE SHAFT PARTS

50° & 80° EQUAL & UNEQUAL U/JOINT

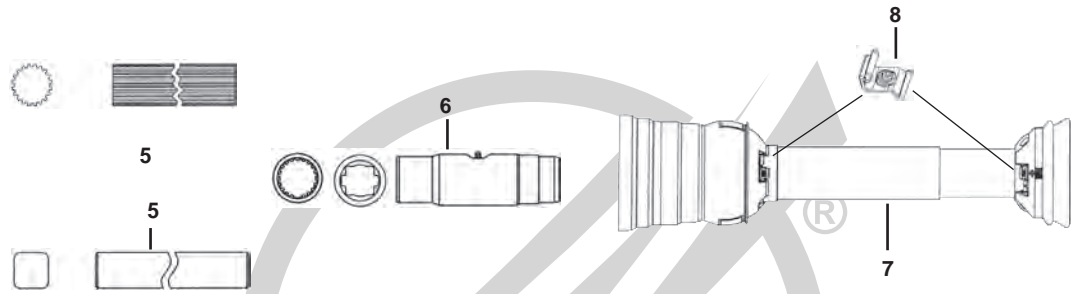

Shaft Identification		Drive Bar 5	Drive Nib 6	80° Cover Guard 7	80° Cover Guard Bearing 8	50° Cover Guard Incl Bearings
Series	U/Joint Size					
1480		14-404-1618  1" x 1 1/8"	14-500-1400	912-1467#  67" Long	921-1400#	14-950-1430
3580		35-404-2120  1 5/16" x 20 Spl	35-501-3500	912-1467#  67" Long	921-1400#	14-950-1430
4480		44-404-2720  1 11/16" x 20 Spl	35-503-3500	912-3579  79" Long	921-3500	-
5580		44-404-2720  1 11/16" x 20 Spl	35-503-3500	912-5579  79" Long	921-5500	55-950-5548

www.walterscheid.com.au

Document No:	SABRECAT
Issue:	1
Issue Date:	20/04/2019

This catalogue is the copyright of HS Company Pty Ltd

# INDENT ITEM ONLY

**NORTH AMERICAN 80° WIDE ANGLE SHAFT PARTS**  
**EQUAL U/JOINT**

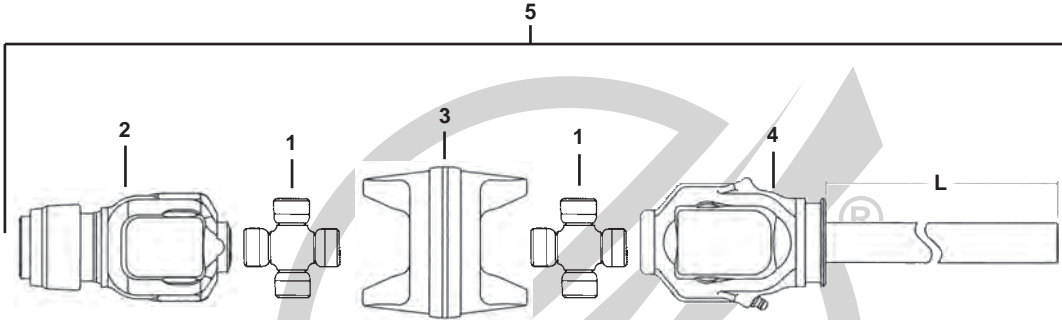

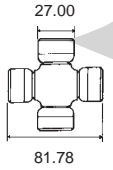
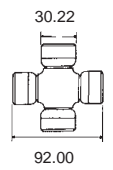
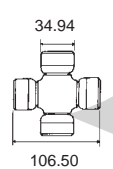
Shaft Identification		Universal Joint 1	QR Yoke Collar Type 2	Centre Yoke 3	Bar Yoke & Shaft 4	Half Shaft Incl. Cover 5
Series	U/Joint Size					
1480		-	14-121-1406# 1 3/8 x 6Spl	14-515-1430#	14-10103800# 1" x 1 1/8" Shaft L=27.250"	14-19553800
			14-121-1421# 1 3/8 x 21Spl			14-19653800
			-			-
3580		-	35-111-8606# 1 3/8 x 6Spl	35-515-8600#	35-10108600# 1 5/16" x 20 Spl Shaft L=27.000"	35-19558600
			35-111-8621# 1 3/8 x 21Spl			35-19658600
			35-111-8620# 1 3/4 x 20Spl			35-19758600
4480	-	-	-	-	-	44-19503506
			-			44-19603521
			-			44-19703520
5580		-	55-111-6806# 1 3/8 x 6Spl	55-515-6800#	55-10106800# 1 11/16" x 20 Spl Shaft L=27.000"	55-19556800
			55-111-6821# 1 3/8 x 21Spl			55-19656800
			55-111-6820# 1 3/4 x 20Spl			55-19756800

North American PTO

www.walterscheid.com.au

Document No:	SABRECAT
Issue:	1
Issue Date:	20/04/2019

# INDENT ITEM ONLY

B:7-68

This catalogue is the copyright of HS Company Pty Ltd

## NORTH AMERICAN 50° WIDE ANGLE SHAFT PARTS

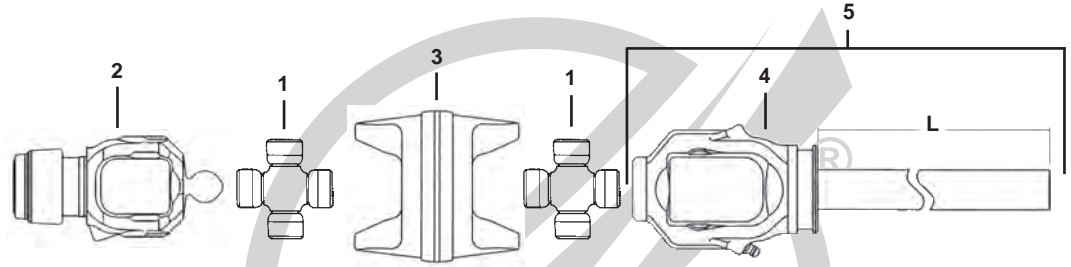

Shaft Identification		Universal Joint 1	QR Yoke Collar Type 2	Centre Yoke 3	Bar Yoke 4	Bar Yoke & Shaft 5
Series	U/Joint Size					
<b>1450</b>		<b>4142000</b> <i>(CPL14N)</i>	<b>14-150-1406</b> 1 3/8 x 6Spl	<b>14-555-1400</b>	<b>14-350-1400</b> 1" Round	<b>14-10501400</b> 1" x 1 1/8" Shaft L=29.380"
			<b>14-150-1421</b> 1 3/8 x 21Spl			
			<b>14-850-1420</b> 1 1/4 x 1/4 Key 2 set screws			
<b>3550</b>		<b>4352000</b> <i>(CP35N-3)</i>	<b>35-151-3506</b> 1 3/8 x 6Spl	<b>35-555-3500</b>	<b>35-350-3500</b> 1" Round	-
			<b>35-151-3521</b> 1 3/8 x 21Spl			
			<b>35-151-3520</b> 1 3/4 x 20Spl			
<b>4450</b>		<b>4442000</b> <i>(RUJ-3009)</i>	-	-	-	-
			-			
			-			
<b>5550</b>		<b>4552000</b> <i>(CP55N)</i>	<b>55-151-5506</b> 1 3/8 x 6Spl	<b>55-555-5500</b>	<b>55-350-5500</b> 1.3" Round	-
			<b>55-151-5521</b> 1 3/8 x 21Spl			
			<b>55-151-5520</b> 1 3/4 x 20Spl			
			<b>55-850-5524</b> 1/2 x 3/8 Key 2 set screws			

Note: Clamp bolt yokes are available in 5550 series

# INDENT ITEM ONLY

Document No:	SABRECAT
Issue:	1
Issue Date:	20/04/2019

**NORTH AMERICAN 80° WIDE ANGLE SHAFT PARTS**  
**WALTERSCHEID REPLACEMENT TRACTOR HALF SHAFT**

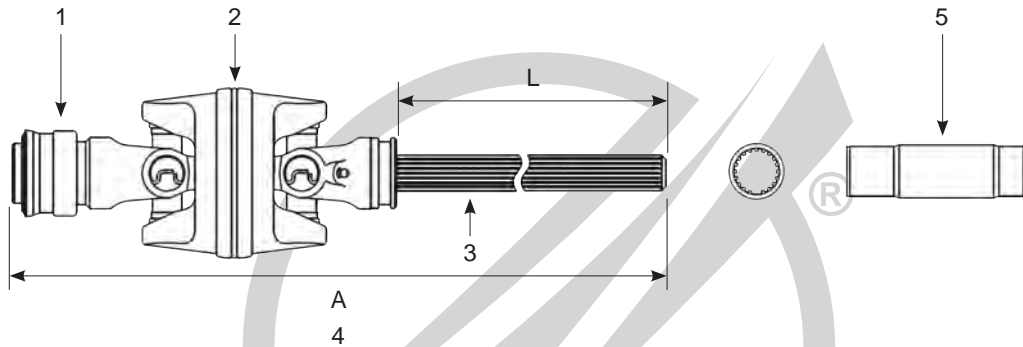

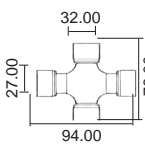
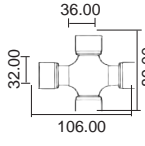
Shaft Identification		QR Yoke Collar Type	Centre Yoke	Splined Drive Bar	Half Shaft Assembly	Drive Nib
Series	U/Joint Size Part No.	1	2	3	A 4	5
2480 Alternate for 3580	 <b>35.06.00</b>	<b>35.83.830</b> 1 3/8 x 6Spl	<b>35.41.05</b>	<b>44-404-2720</b> 1 3/4" x 20 Spl L=895mm	<b>AGH2480-SP-895</b> A=1200mm <i>(Alternate for 35-19558600)</i>	<b>35-503-3500</b>
		<b>35.83.832</b> 1 3/8 x 21Spl			-	
		<b>35.84.112</b> 1 3/4 x 20Spl			-	
2580 Alternate for 4480 and 5580	 <b>36.06.00</b>	<b>36.83.110</b> 1 3/8 x 6Spl	<b>36.41.05</b>	<b>44-404-2720</b> 1 3/4" x 20 Spl L=685mm	<b>AGH2580-SP-685</b> A=1060mm <i>(Alternate for 44-19503506)</i> <i>(Alternate for 55-19556800)</i>	<b>35-503-3500</b>
		<b>36.83.112</b> 1 3/8 x 21Spl			<b>AGH2580-SP-6851</b> A=1060mm <i>(Alternate for 44-19603521)</i> <i>(Alternate for 55-19656800)</i>	
		<b>36.84.112</b> 1 3/4 x 20Spl			<b>AGH2580-SP-6852</b> A=1060mm <i>(Alternate for 44-19703520)</i> <i>(Alternate for 55-19756800)</i>	

Half Shafts are fitted with Walterscheid CV assemblies.

North American PTO

# INDENT ITEM ONLY

B:7-70

www.walterscheid.com.au

Document No:	SABRECAT
Issue:	1
Issue Date:	20/04/2019

This catalogue is the copyright of HS Company Pty Ltd